

5.1.2

LIFE SKILLS

**[YOGA, HEALTH & HYGIENE AND
ICT]**

[Supporting Documents]

FOR

ACADEMIC YEAR 2022-2023

DIRECTOR
KOSHY'S INSTITUTE OF MANAGEMENT STUDIES
31/1, Kadusonnappanahalli,
Kannur Po, Hennur-Bagalur Road,
Bangalore-562 149

DEPARTMENT OF BBA AVIATION

Date:14/06/2023

Circular

This is to inform all the students and faculty members that yoga day will be celebrated on 26/06/2023 on the occasion of “International Yoga Day” at 9:30am in auditorium. We invite all of you attend the program.

DIRECTOR
KOSHYS INSTITUTE OF MANGEMENT STUDIES
31/1, Kadusonnappanahalli,
Kannur Po, Hennur-Bagalur Road,
Bangalor-562 149

Director



Report on International Yoga Day celebration Academic Year 2022-23

On June 26, 2023, Koshy's Group of Institutions marked International Yoga Day with a celebratory event in the Auditorium at 10 am, led by Akshatha S, Assistant Professor at KIMS.



“Speaker Akshatha.s the yoga day celebration as on 26-june-2023”

The celebration of International Yoga Day at KIMS achieved remarkable success, inspiring individuals to embark on a journey of self-discovery and holistic wellbeing through yoga. It emphasized the significance of prioritizing both physical and mental health in today's fast-paced world. Looking ahead, KIMS remains steadfast in its commitment to promoting yoga as a pathway to nurturing a healthier and more harmonious college community.



Kadavil
DIRECTOR
KOSHY'S INSTITUTE OF MANAGEMENT STUDIES
31/1, Kadusonappanahalli,
Kannur Po, Hennur-Bagalur Road,
Bangalore-562 149

Director



Scanned with OKEN Scanner

ACADEMIC YEAR 2022-23
INTERNATIONAL YOGA DAY
ATTENDANCE SHEET

-

SL.NO	STUDENT NAME	SIGNATURE
1	Arjun P V	P
2	Abhay M	P
3	ABHISHEK MAHESH	P
4	ASHIF SHAHABIN V	P
5	RONITH H R	P
6	KEVIN C BYJU	P
7	KUNALAN V	P
8	MUHAMMED HASHIM	A
9	SHAHID S	P
10	BHUPATHI R HARI	P
11	Samiya Iram	P
12	PRATHAM SOMJIYANI	P
13	B M YOGESH KUMAR	P
14	AISHWARYA M	A

Prathambon
DIRECTOR
KOSHYS INSTITUTE OF MANGEMENT STUDIES
31/1, Kadusonnappannahalli,
Kannur Po, Hennur-Bagalur Road,
Bangalor-562 149



15	CHANDANA N	P
16	Charan R	P
17	HEMALATHA N	P
18	HARSHITHA R	P
19	SREELIMA MANOJAN	P
20	ABHIN M	P

Prasanna
DIRECTOR
KOSHS INSTITUTE OF MANGEMENT STUDIES
31/1, Kadusonnappanahalli,
Kannur Po, Hennur-Bagalur Road,
Bangalor-562 149





KOSHYS

INSTITUTE OF MANAGEMENT STUDIES

NAAC Accredited & ISO 9001 2015 Certified

Date: 17/06/2023

Circular

Koshys Institute of Management Studies is celebrating yoga day on 21/06/2023 on occasions of "International Yoga Day" at 9:30am in auditorium. We invite all the staffs and students for the same and we are conducting yoga session interested individuals can participate.

Principal

Director
DIRECTOR
KOSHYS INSTITUTE OF MANAGEMENT STUDIES
31/1, Kadusonnappanahalli
Kannur Po, Hennur-Bagalur Rd
Bengaluru - 560 077





KOSHYS

INSTITUTE OF MANAGEMENT STUDIES

NAAC Accredited & ISO 9001 2015 Certified

Report on International Yoga Day Celebration Academic Year 2022-23

International Yoga Day was celebrated as on 21st June 2023 in the Auditorium at 9.30 am by the Koshys Institute of Management Studies.

Dr Sareena Shaji, Dean, Koshys group of institution, along with Dr. Prakash B Nayak, Academic Director, inaugurated the event in the presence of the entire KGI teaching, non-teaching staff and all the students.

Prof, Sandhya, Principal of KIMS introduced Professor Rajni Gaur from KIMS, who was the yoga instructor for the event.

We celebrated Yoga Day with all the students by practicing one hour Power yoga session.

As we all know that “Yoga is an invaluable gift of India’s ancient tradition. It embodies unity of mind and body; thought and action; restraint and fulfilment; harmony between man and nature; a holistic approach to health and well-being. It is not about exercise but to discover the sense of oneness with yourself, the world and the nature. By changing our lifestyle and creating consciousness, it can help in well being. Let us work towards adopting an International Yoga Day.”

Outcome:

- In this yoga session both UG and PG students are participated around 200 students were participated.
- Students got to know about the power of meditation and the procedure to practice it.
- Students got the knowledge in various types of yoga postures for balance mind and body.



Prakash B Nayak
DIRECTOR
KOSHYS INSTITUTE OF MANGEMENT STUDIES
31/1, Kadusonnappanahalli,
Kannur Po, Hennur-Bagalur Road,
Bangalor-562 149



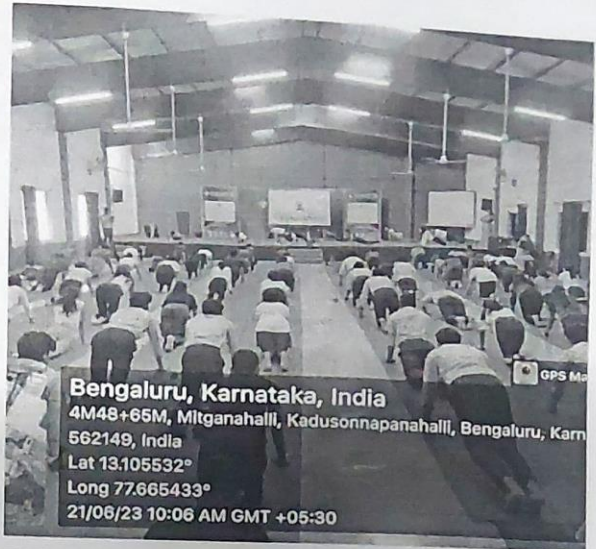

Bengaluru, Karnataka, India
4M48+65M, Mitganahalli, Kadusonnapanahalli, Bengaluru, Karn
562149, India
Lat 13.105532°
Long 77.665433°
21/06/23 10:06 AM GMT +05:30



Bengaluru, Karnataka, India
4M48+65M, Mitganahalli, Kadusonnapanahalli, Bengaluru, K
562149, India
Lat 13.105689°
Long 77.665455°
21/06/23 10:14 AM GMT +05:30

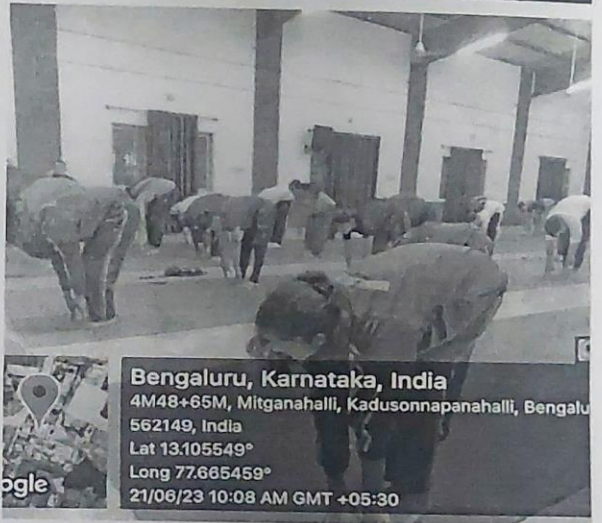

Bengaluru, Karnataka, India
4M48+65M, Mitganahalli, Kadusonnapanahalli, Bengaluru
562149, India
Lat 13.105549°
Long 77.665459°
21/06/23 10:08 AM GMT +05:30

low
DIRECTOR
DIRECTOR
KOSHY'S INSTITUTE OF MANAGEMENT STUDIES
31/1, Kadusonnappanahalli,
Kannur Po, Hennur-Bagalur Road
Bengaluru - 560 077



KOSHY'S

INSTITUTE OF MANAGEMENT STUDIES

NAAC Accredited & ISO 9001 2015 Certified

YOGA DAY
ACADEMIC YEAR 2022-23
ATTENDANCE SHEET

DATE: 21/06/2023

SL.NO	STUDENT NAMES	DEPARTMENT	SIGNATURE
1	Vaishini.M.	B.Com.	Vaishini.M.
2	Ranjitha.R.	B.Com.	Ranjitha.R.
3	Hamsa Veni	B.Com.	Hamsa Veni
4	Sharada.R.	B.Com.	Sharada.R.
5	Kusuma.R.	B.Com.	Kusuma.R.
6	Monika.R.	B.Com.	Monika
7	Chandira.T	BBA	Chandira.T
8	Abhinand k.R	B.Com.	Abhinand
9	Ven	BBA	Ven
10	Hareesh.G.R.	B.Com.	Hareesh
11	BAZALEL BABOY	B.Com.	Bazalel
12	Sooraj.B	B.Com.	Sooraj
13	JOHN JOSEPH	B.COM	John
14	Akash.S.NAIR	B.Com.	Akash
15	Dikshan.A.D	B.Com.	Dikshan
16	Akshay Resh	B.Com.	Akshay
17	Aswath Krishna AV	B.Com.	Aswath
18	Ganbeer Aswath	BCA	Ganbeer
19	Mahammed usman	B.COM	Mahammed
20	Aadhal Sebastien	BBA	Aadhal
21	Dhiya	B.Com.	Dhiya
22	Christy	BCA	Christy
23	Seethasa	BBA	Seethasa
24	Muhammed sahal	B.Com.	Muhammed
25	Sia. NAS NASAR	B.Com.	Sia
26	Thaha zeep .A.k	B.COM	Thaha zeep
27	Abhinand k.R	B.COM	Abhinand
28	Shreya	BBA	Shreya
29	Shreyas.H.A	B.Com.	Shreyas
30	Shreyas.M	B.Com.	Shreyas
31	Abhilash.H.S	B.COM	Abhilash
32	Deepika	BBA	Deepika
33	Hamam	B.COM	Hamam
33	Likitha Kumari NB	BBA	Likitha
34	Likitha Kumari H.R	B.Com.	Likitha
35	Likitha Kumari	BBA	Likitha
36	AKSHAY	B.COM	AKSHAY

DIRECTOR
KOSHY'S INSTITUTE OF MANAGEMENT STUDIES
3171, Kadusonnappanahalli,
Kannur Po, Hennur-Bagalur Road,
Bangalore-562 149

37	Roselin	BBA	Roselin
38	Barath S	B.COM	Barath
39	Nithya	BBA	Barath
40	ABHISHEK MR	B.COM	ABHI
41	Yoga Vishwas	B.COM	Yoga Vishwas
42	Chiranth Gowda	B.COM	Chiranth
43	Dhanush V	B.COM	Dhanush
44	Nadin	B.COM	Nadin
45	Parusha than	B.COM	Parusha than
46	ASWIN MANOJ	B.COM	Aswin
47	GOKUL J	B.COM	Gokul
48	YASHASHWIN P	B.COM	Yashashwin
49	MUBASHIR BIN JAFAR	B.COM	Mubashir
50	Muhammed Shifin-P	B.COM	Muhammed
51	Arshiya	BBA	Arshiya
52	Miliza	BCA	Miliza
53	Nanu Gowda	B.COM	Nanu
S.C.F	Sonu Seivasa	BA	Sonu
55	Pradheep S	BCA	Pradheep
56	Eshwar	BBA Aviation	Eshwar
57	D Prathap	BBA ITA	D Prathap
58	Rakshith	BBA	Rakshith
59	Namastha Gowda	BA	Namastha
60	Chandhu	BCA	Chandhu
61	Punith Gowda	BBA	Punith
62	Abhirava	BCA	Abhirava
63	ANUSHA P	B.COM	Anusha
64	Sahana	BCA	Sahana
65	Supriya M	BBA	Supriya
66	Rashmi B.m	B.COM	Rashmi
67	AKSHAY kumar	B.CA	Akshay



KOSHYS

INSTITUTE OF MANAGEMENT STUDIES

NAAC Accredited & ISO 9001 2015 Certified

DEPARTMENT OF COMPUTER APPLICATIONS

Date: 13/06/2023

CIRCULAR

The Department of Computer Applications is organizing a Seminar on "SMART CITIES with IOT" for 2nd, 4th and 6th Semester BCA students on 15th June 2023. All the students should attend this Seminar without fail and gain the knowledge.

Venue: Auditorium

Date: 15th June 2023

Time: 11:00am-01:00pm

S. Uday
HoD

Principal

Director

DIRECTOR
KOSHYS INSTITUTE OF MANAGEMENT STUDIES
31/1, Kadusonnappanahalli,
Kannur Po, Hennur-Bagalur Road,
Bangalore-562 149





KOSHYS

INSTITUTE OF MANAGEMENT STUDIES

NAAC Accredited & ISO 9001 2015 Certified

Report on Seminar

Topic: " SMART CITIES with IOT "

Date:15/06/2023, Day: Thursday, Time:11:00am- 01:00pm

Preamble: Koshys College, BCA Department took an initiative in conducting seminar on " SMART CITIES with IOT " in order to train and up skill students with various IOT concepts and its application in various cities and also on varied concepts which pays a way towards holistic development.

Speaker's profile: Dr Sashikanth Reddy A, Accomplished IoT specialist with a passion for delivering wearable devices, solutions to security protocols for sensor data, low power energy protocols for microcontroller implementations. Had delivered more than 20 workshops on Internet of Things – Hands on with different ARM based microprocessors and microcontrollers. Has 5 Scopus indexed Q2 publications to my name. Completed research project on developing mobile application to diagnose urticaria diseases funded by DTS. Guided students at Smart India Hackathon competition and team stood among top 10 innovative project for 3 time (in 2017, 2018 & 2019).

Participant's profile: All the 6th, 4th and 2nd semester of BCA students participated.

Description: The Seminar started with giving real time introduction to IOT followed with definition; how IOT are related to real life, how IOT will help to build smart cities in European nations. - And also the seminar was focused on The foundation of smart cities relies on the utilization of Internet of Things (IoT) devices and networks. These devices, in combination with software solutions, user interfaces, and communication networks, enable and enhance the functioning and efficiency of smart cities.

Ultimately, the goal is to have IoT technologies interconnected, with data flowing seamlessly between devices, in order to create a truly smart city that can improve quality of life. More specifically, these IoT technologies include radio-frequency identification (RFID), near-field communication (NFC), low-power wide-area (LPWA), wireless telecommunications, wireless sensor network (WSN), DASH7, and addressing.

IoT Technologies for Smart Cities

Radio-frequency identification (RFID) tagging devices use radio frequencies to transfer data, mainly to track and identify objects and people. In a smart city, tracking the location and movement of vehicles, equipment, and even people can generate important data that can be used to optimize the operation of transportation systems, waste collection routes, and parking availability.

Near-field communication (NFC) is a set of standards for smartphones and other devices – like credit card readers – to establish radio communication with each other by bringing them into close proximity, typically within an inch (or a few centimeters). In smart cities, NFC is used for bidirectional short-distance communication, such as contactless payments, access control, and electronic ticketing

Prasanth

DIRECTOR
KOSHYS INSTITUTE OF MANAGEMENT STUDIES
31/1, Kadusonnappanahalli,
Kannur Po, Hennur-Bagalur Road,
Bangalore-562 149



Low-power wide-area (LPWA), in licensed spectrum, is an optimal solution for IoT applications that require low-power, low-cost, and low-bandwidth communication. At the same time, LPWA technologies benefit from battery life of ~10 years.

In a smart city, LPWA networks are used in applications such as building automation and industrial automation – part of the Industrial Internet of Things (IIoT).

3G, 4G Long-Term Evolution (LTE), and 5G are cellular wireless telecommunications standards that have been primarily used by mobile phones and data terminals. Importantly, 5G offers lower latency, increased speed, higher density (# of connected devices), added capacity (network throughput), and energy efficiency, as compared to prior wireless generations.

A wireless sensor network (WSN) is a network that is untethered to any wires and comprises a large number of small, low-power devices called sensor nodes. Specifically, these nodes are equipped with sensors, microcontrollers, and wireless communication capabilities, and are deployed in a variety of environments to monitor and collect data.

Sir also explained about application like,

1) Smart Urban Mobility

- Traffic Monitoring
- Smart Parking
- Connected Vehicles

2) Urban Sustainability

- Smart Lighting
- Smart Meters
- Smart Waste Management

3) Smart Buildings and Environment

- Air Quality Monitoring
- Building Automation
- Noise Monitoring

The entire program was coordinated with the support of the chairman sir, Dean mam, COO sir, Director sir, Principal mam and faculties of BCA Department for their support for the smooth conduct of the Seminar

Feedback: The Seminar was very Interactive and Informative, students gained knowledge about the IOT devices and there uses in our day to day lives and indeed knowledge in Cities with IOT. Also got good response during the questionnaire session.

Praveen
DIRECTOR
KOSHYS INSTITUTE OF MANGEMENT STUDIES
31/1, Kadusonnappanahalli,
Kannur Po, Hennur-Bagalur Road,
Bangalor-562 149



Photo Gallery

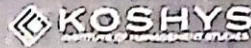

Department Of Computer Applications

Organizing a Seminar on

"SMART CITIES with IOT"



Dr. Sashikanth Reddy AMCA 120-C5

Research Head, Parvati Consultech, Bengaluru
Associate Professor, MITTE Institute of Technology, Bengaluru

Venue: Auditorium | Date: 15th June 2023 | Time: 11:00am-01:00pm

No.31/1, Kannur Po, Hennur-Bagalur Road, Mitganahalli,
Kadusonnappanahalli, Bengaluru, Karnataka 562149



Bengaluru, Karnataka, India

Unnamed Road, Mitganahalli, Kadusonnappanahalli, Bengaluru,
Karnataka 562149, India

Lat 13.105476°

Long 77.685856°

15/06/23 11:44 AM GMT +05:30

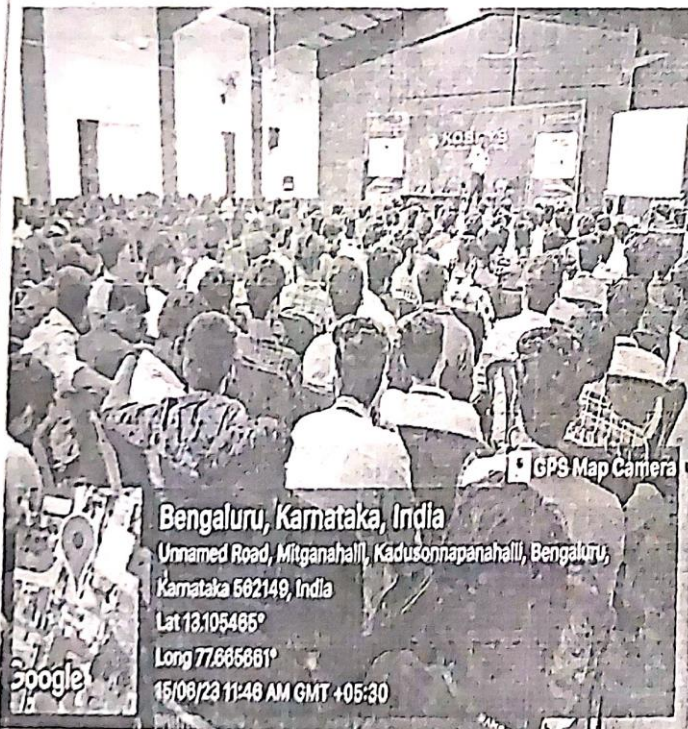

Bengaluru, Karnataka, India

Unnamed Road, Mitganahalli, Kadusonnappanahalli, Bengaluru,
Karnataka 562149, India

Lat 13.105485°

Long 77.685861°

15/06/23 11:48 AM GMT +05:30

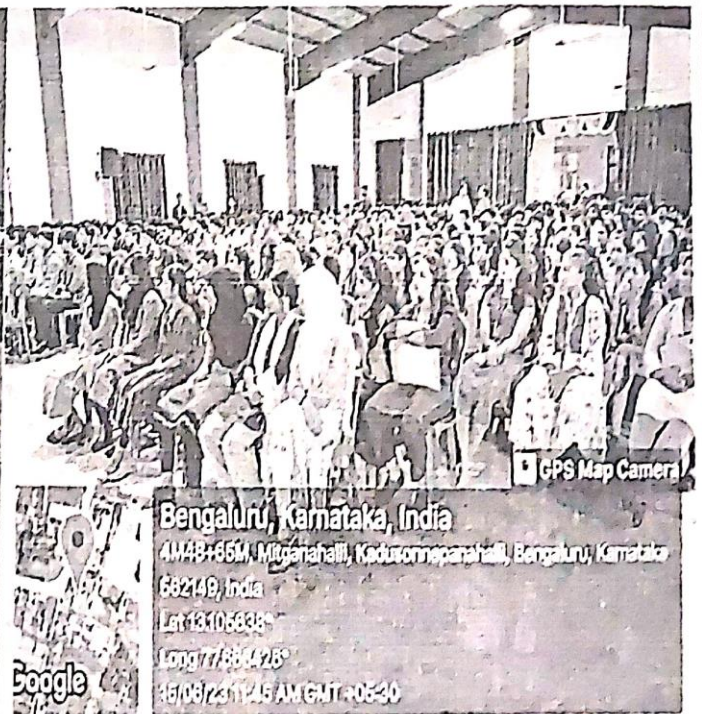

Bengaluru, Karnataka, India

4M48+85M, Mitganahalli, Kadusonnappanahalli, Bengaluru, Karnataka
562149, India

Lat 13.105638°

Long 77.684428°

15/06/23 11:45 AM GMT +05:30

S. I. [Signature]
HoD

[Signature]
Principal

[Signature]
Director

KOSHYS INSTITUTE OF MANAGEMENT STUDIES,
31/1, Kadusonnappanahalli,
Kannur Po, Hennur-Bagalur Road
Bangalore-562 149





STUDENT ATTENDANCE LIST

Date: 15/06/2023

Sl No	Register No	Name	Signature
1	U19BU2250090 Abhinav P Anil	Abhinav P. Anil	
2	U19BU2250087	Anwar mubarak E.N	
3.	U19BU2250092	AKSHAY DEU JOJI	
4.	U19BU2250131	Amal nath .T	
5.	U19BU2250145	Sanju Sibi	
6.	U19BU2250108	Melvin Sabu	
7.	U19BU2250141	Sivaramakrishnan.A	
8.	U19BU2250152	Ridhul Raj K	
9.	U19BU2250164	Md. Saleem	
10	U19BU2250122	P. Jibin Anto	
11	U19BU2250111	BHARATH KUMAR.A	
12.	U19BU2250098	Vishal.N	
13.	U19BU2250168	Keshor.VS	
14	U19BU2250157	P. Nikitha	
15	U19BU2250168	Chethana B.N	
16	U19BU2250158	Prakruthi.L	
17	U19BU2250144	Lakshmi.G.	
18	U19BU2250161	Divya.C	
19.	U19BU2250106	Noor aysha	
20	U19BU2250162	Vinutha.M	
21.	U19BU2250127	Bhavana.M.V	
22	U19BU2250117	Sofiya.M	
23	U19BU2250146	Nandana Rajeev	
24	U19BU2250112	Hasanath.	



KOSHYS

INSTITUTE OF MANAGEMENT STUDIES

NAAC Accredited & ISO 9001:2015 Certified

STUDENT ATTENDANCE LIST

Date: 15/06/2023

Sl No	Register No	Name	Signature
1	214	AMAL. A	
2	243	Abhishek. M. Babu	
3	244	Chaitra Saran	
04	175	Nivedh S Babu	
05	177	Nived. P	
06	181	Vignesh. V	
07	176	MELBIN. S	
08	251	PBHITH. P	
09	238 238	Abhimanyu. K.	
10	209	Nidhin Manoj	
11	257	Asif. TM	
12	178	Rohith. S	
13	219	Sarbas. A.T	
14	212	Neeraj. k	
15	179	MUHAMMED SHANIL	
16	208	Akash poasad	
17	199	Vishnu. C. Pillai	
18	194	Narendra Babu. N	
19	215	Adil Muhammed.	
20	183	Bharathio D	
21	181	Vignesh	
22	193	Yuvraj Singh	
23	211	Akash. mp	
24	242	Ajay Sagar	

Prasanna

DIRECTOR
 KOSHYS INSTITUTE OF MANAGEMENT STUDIES
 # 31/1, Kadusonnappanahalli,
 Kannur Po, Hennur-Bagalur Road,
 Bangalor-562 149



DEPARTMENT OF COMPUTER APPLICATIONS

10-01-2023

CIRCULAR

The Department of Computer Applications is organizing two days Boot Camp workshop on "Cyber Security" for BCA students on 19th and 20th January 2023. Interested students should pay an amount of Rs.200 and register yourself for the workshop to the coordinators on or before 15th January 2023. Hands-on sessions and certificate will be provided for the workshop.

Venue : Computer Lab 1 & 2

Faculty Coordinator : Prof. S Uma Mageswari, Prof. Navya Francis

CC:

Principal

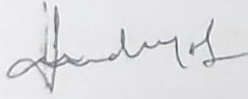

HoD

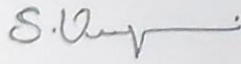

Event Coordinator

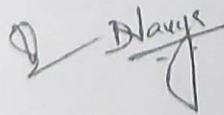

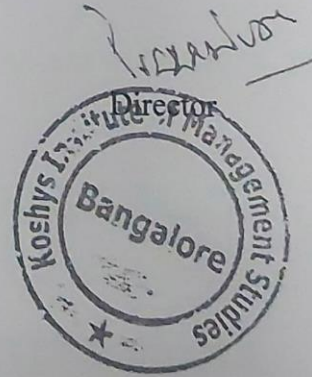

Prasanna

DIRECTOR
KOSHYS INSTITUTE OF MANAGEMENT STUDIES
31/1, Kadusonnappanahalli,
Kannur Po, Hennur-Bagalur Road,
Bangalore-562 149





KOSHYS

INSTITUTE OF MANAGEMENT STUDIES

NAAC Accredited & ISO 9001 2015 Certified

Department of Computer Applications

Report on Two days Boot Camp Workshop on "Cyber Security"

Date: 19th and 20th January 2023

Time: 9:00am- 3:00pm

Venue: Computer Lab

Preamble: Koshys College, Department of Computer Applications took an initiative in conducting Boot Camp on 19th and 20th January 2023 to upskills the students with the hands-on training on Cyber Security.

Speaker's profile: Abhishek Madeshia, Co-founder of Lyfaux Technology Private Limited and Techzyer.

He has a wealth of experience in penetration testing, vulnerability assessments, and incident response. He is proficient in a wide range of programming languages and frameworks including Flutter, Laravel and Solidity. He is well-versed in blockchain platforms such as Ethereum and Vulkan.

His expertise in web and app development allows him to design and build secure and user-friendly applications that meet the needs of his clients.

Participant's profile: All the three semester of BCA students (interested students) participated. 160 students participated in the Boot Camp.

Description: The workshop started with inaugural function and a brief introduction about the speaker and about the firm was given to students. Then the speaker, Mr. Abhishek briefed them about what is Cyber security and what are the different approaches to address the same was discussed.

Page 1

Prakash
DIRECTOR
KOSHYS INSTITUTE OF MANAGEMENT STUDIES
31/1, Kadusonnappanahalli,
Kannur Po, Hennur-Bagalur Road,
Bangalore-562 149



He taught them from the basics of Cyber Security and gave them a clear idea about Phishing and how to tackle it. Performing Camera and location Hack using Stombreaker. Hands on training for the same was given to the students and it was very helpful to the students.

The entire program was coordinated with the support of the Chairman, Dean, Academic Advisor, Director, Vice Principal, HoD and faculties of BCA Department.

Feedback: Boot Camp was very Interactive and Informative, students gained knowledge about Cyber security and its importance in our real life. Questionnaire session was very good, and responses have cleared the doubts of students.

Photo Gallery

KOSHYS
INSTITUTE OF MANAGEMENT STUDIES

Department of BCA
Workshop on
“Cyber Security”

Time: 09:00 AM
to 03:00 PM

19th & 20th
January 2023
Venue: Computer Lab 1 & 2

Abhishek Madeshia
Lyfaux Technology Private Limited and
Techzyer, Bengaluru

www.kgi.edu.in

DIRECTOR
KOSHYS INSTITUTE OF MANGEMENT STUDIES
31/1, Kadusonnappanahalli,
Kannur Po, Hennur-Bagalur Road,
Bangalor-562 149

Prakashan

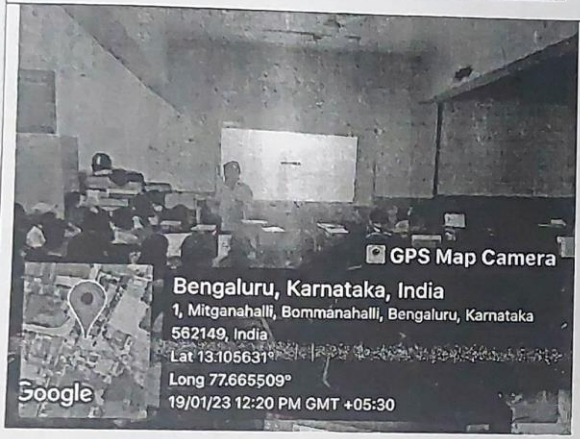
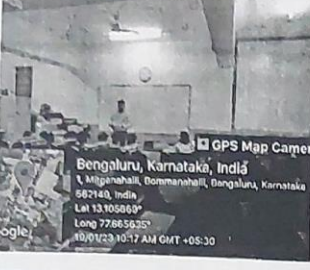

Event Coordinators: Prof. S Uma Mageswari *S.U.M*
 Prof. Navya Francis *Navya*

S.U.M
 HOD

Pradeep
 Director



DIRECTOR
 KOSHYS INSTITUTE OF MANAGEMENT STUDIES
 # 31/1, Kadusonnappanahalli,
 Kannur Po, Hennur-Bagalur Road
 Bangalore-562 149



DEPARTMENT OF COMPUTER APPLICATIONS BOOTCAMP on CYBER SECURITY

Attendance Sheet

Sl. No.	Student Name	Sem	Sec	19.01.2023		20.01.2023	
				Morning	Afternoon	Morning	Afternoon
23	Abhishek M. Babu ✓	1 st	C	AB	AB	AB	AB
24	A MAL: A ✓	1 st	C	AM	AM	AM	AM
25	Adwaith: S. Krishna ✓	1 st	C	AD	AD	AD	AD
26	Milvan Issac Mathew ✓	1 st	C	Milvan	Milvan	Milvan	Milvan
27	Jerin George ✓	III rd	B	JG	JG	JG	JG
28	Jerin Jerome Justin ✓	III rd	B	JJ	JJ	JJ	JJ
29	Amarjith M.S ✓	III	A	AM	AM	AM	AM
30	Jishnu G. Nair ✓	III rd	B	JN	JN	JN	JN
31	Devalat V. Prasad ✓	III rd	B	DP	DP	DP	DP
32	Shebin Shaje ✓	V	B	SS	SS	SS	SS
33	Shanu Joseph ✓	V	B	Shanu	Shanu	Shanu	Shanu
34	Nishant Joseph	III	E				
35	Ujwala B ✓	III rd	D	Ujwala	Ujwala	Ujwala	Ujwala
36	Asbeen Kousar ✓	III	A	AK	AK	AK	AK
37	Apoorva ✓	III	A	AP	AP	AP	AP
38	Nishant kumare ✓	III	C	NK	NK	NK	NK
39	Lokesh Varma ✓	V	A	LV	LV	LV	LV
40	Arvin U.K ✓	V	C	AR	AR	AR	AR
41	Jithu Sreekumar ✓	1 st	C	JS	JS	JS	JS
42	Joshin Abraham ✓	V	A	JA	JA	JA	JA
44	Allen Albino						
	Prince M Varghese						

DIRECTOR
 KOSHYS INSTITUTE OF MANAGEMENT STUDIES
 # 31/1, Kadusonnappanahalli,
 Kannur Po, Hennur-Bagalur Road,
 Bangalore-562 149

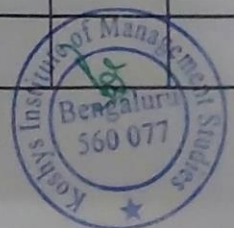

DEPARTMENT OF COMPUTER APPLICATIONS
BOOTCAMP on CYBER SECURITY

Attendance Sheet

Sl. No.	Student Name	Sem	Sec	19.01.2023		20.01.2023	
				Morning	Afternoon	Morning	Afternoon
1	Muhammed Shafi R	1st	B	Present	Present	Present	Present
2	Nijin Biju	1st	B	Present	Present	Present	Present
3	Aflah CK	1st	A	Present	Present	Present	Present
4	Goutham Raj	1st	A	Present	Present	Present	Present
5	Muhammed Safer M	1st	C	Present	Present	Present	Present
6	ANJO R	1st	A	Present	Present	Present	Present
7	A. Ann Brudzor	1st	C	Present	Present	Present	Present
8	VISMAY A.V	1st	D	Present	Present	Present	Present
9	Vysakh A	1st	D	Present	Present	Present	Present
10	Albin Thomas	1st	A	Present	Present	Present	Present
11	Adithya Kumar V	1st	D	Present	Present	Present	Present
12	Mohamed Sabal	1st	D	Present	Present	Present	Present
13	Muhammad Yasin M	1st	A	Present	Present	Present	Present
14	Nabhan E	1st	DD	Present	Present	Present	Present
15	Suhail KI	1st	B	Present	Present	Present	Present
16	Hamsath Rahman C	1st	D	Present	Present	Present	Present
17	Rinu Mathew	1st	B	Present	Present	Present	Present
18	Aby Shaji	1st	D	Present	Present	Present	Present
19	Sankeerth P.R	1st	D	Present	Present	Present	Present
20	Jeerson P.ommen	1st	A	Present	Present	Present	Present
21	Steve and Augustine	1st	B	Present	Present	Present	Present
22	Jaster P James	1st	D	Present	Present	Present	Present

DIRECTOR
KOSHYS INSTITUTE OF MANAGEMENT STUDIES
31/1, Kadusonnappanahalli,
Kannur Po, Hennur-Bagalur Road,
Bangalore-562 149





KOSHYS

INSTITUTE OF MANAGEMENT STUDIES

NAAC Accredited & ISO 9001 2015 Certified

DEPARTMENT OF COMPUTER APPLICATIONS

DATE: 30/06/2023

CIRCULAR

The Department of Computer Applications organizing a Workshop and Hands on Training on "FULL STACK DEVELOPMENT" for 6th Semester BCA students on 4th and 5th July 2023. All the students should attend this workshop without fail and gain the knowledge.

Venue: BCA Lab 2

Date: 4th July 2023

5th July 2023

Time: 9:00am-3:00pm

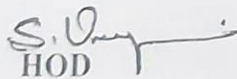

HOD

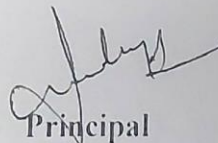
Principal

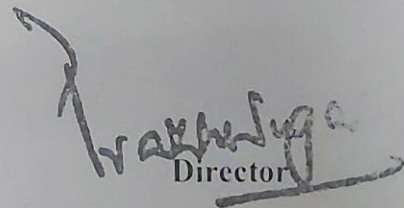
Director

Event Coordinator: Prof. Anusha P P

DIRECTOR
KOSHYS INSTITUTE OF MANAGEMENT STUDIES
31/1, Kadusonnappanahalli,
Kannur Po, Hennur-Bagalur Road,
Bengaluru - 560 077





KOSHYS
INSTITUTE OF MANAGEMENT STUDIES

Department of Computer Applications

REPORT ON WORKSHOP AND HANDS ON TRAINING

Workshop and Hands on Training “FULL STACK DEVELOPMENT”

Date:04/07/2023 and 05/07/2023, Day: Tuesday and Wednesday, Time:9:00am- 3:00pm

Preamble: Koshys College, BCA Department took an initiative in conducting two days workshop and hands on training on **FULLSTACK DEVELOPMENT** on 4th and 5th July 2023.

Speaker’s profile: Mr. Subhani Shaik ,Assistant Professor in HKBK Degree College

Participant’s profile: 6th semester BCA students participated.

Description: The Workshop started with frontend development. Discussed more about full stack development. The workshop mainly focused on the following practical session.

- Frontend Development
- Backend Development
- Frameworks
- Languages
- Domains
- Wordpress (Theory and Practical)
- Web Development using wordpress.



The entire program was coordinated with the support of the chairman sir, Dean mam, Academic Advisor mam, Director sir, Principal mam, HOD mam and faculties of BCA Department for their support for the smooth conduct of the guest lecture.

Feedback: Workshop was Interactive and Informative, students gained knowledge about Fullstack development. Also got good response during the practical session.

Prashant
DIRECTOR
KOSHYS INSTITUTE OF MANGEMENT STUDIES
31/1, Kadusonnappanahalli,
Kannur Po. Hennur-Bagalur Road,
Bangalor-562 149



Photo Gallery

 **KOSHYs**
INSTITUTE OF MANAGEMENT STUDIES

DEPARTMENT OF BCA
is conducting a
WORKSHOP AND HANDS ON TRAINING ON
Full Stack Development



Date: 4th & 5th July 2023
Venue: Lab 2
Time : 9 AM to 3 PM

SUBHANI SHAIK
Assistant Professor (HKEK College)

No.31/1, Kannur Po, Hennur-Bagalur Road, Miltanahalli,
Kadusonnappanahalli, Bengaluru, Karnataka 562149

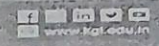
 www.kgi.edu.in

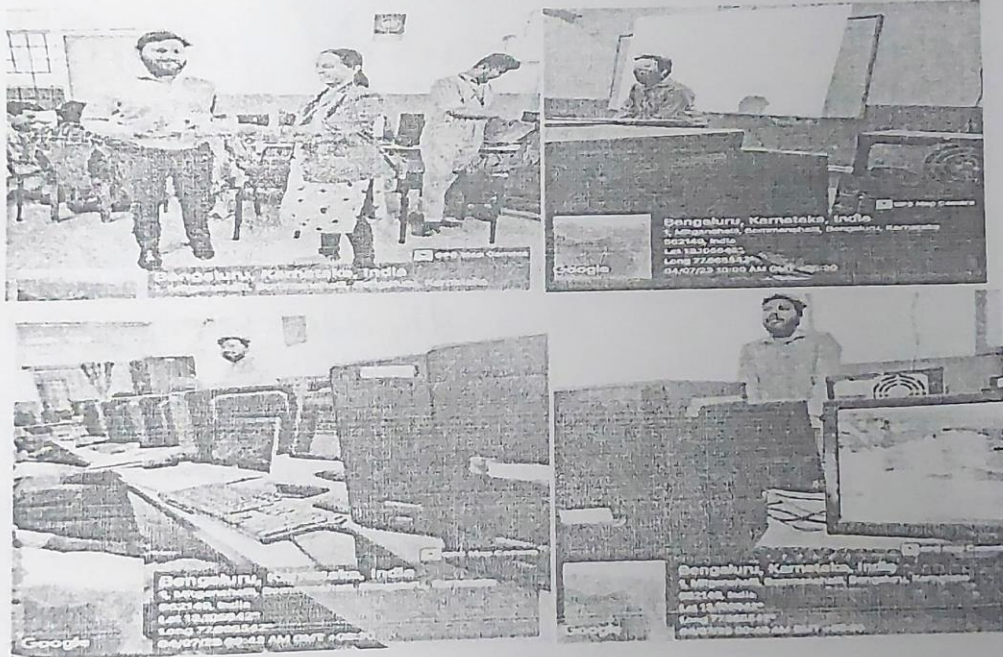

Event Coordinator: Anusha P P

S. Vijay
HOD

Department Of Computer Application

WBA

Prasanth
DIRECTOR
KOSHYs INSTITUTE OF MANGEMENT STUDIES
31/1, Kadusonnappanahalli,
Kannur Po, Hennur-Bagalur Road,
Bangalor-562 149





KOSHYS

INSTITUTE OF MANAGEMENT STUDIES

NAAC Accredited & ISO 9001:2015 Certified

STUDENT ATTENDANCE LIST

WORKSHOP AND HANDS ON TRAINING: "FULL STACK DEVELOPMENT"

Date: 05/07/2023

SL NO	REGISTER NUMBER	NAME	SIGNATURE
1.	R2014278	Monika S N	
2.	R1918423	Arvin	
3.	R2014291	Ramkumar. E	
4.	R2014263	Laxanya. N	
5	R2014201	Abhijith. C. H	
6	R2014261	Kurakose. S. M	
7	R2014202	Abhijith. B	
8	R2014260	Krishmapriya	
9.	R2014305	S. Rajeshwar	
10	R2014235	B. Lokesh Varma	
11	R2014208	Abin Sheen	

Prakash
DIRECTOR
KOSHYS INSTITUTE OF MANAGEMENT STUDIES
31/1, Kadusonnappanahalli,
Kannur Po. Hennur-Bagalur Road,
Bangalore-562 149



12	R2014239	Bindhu B.M	
13	R2014227	Archana N	
14	R2014314	Thejas C	
15	R2016038	Praduman Kumar	
16	R2014308	Shilpa Shree K.V	
17	R2014318	Wisath S	
18	R2014273	Mohammed Nimal Shan	
19	R2014279	Muhammadu Raihan BK	
20	R2014203	Abhinand P	
21	R2016002	ADARSH K H	
22	R2016003	AGIN M	
23	R2016027	ITHA HAS A	
24	R2014312	Sreejith K.M	
25	R2014296	Robink Philip	
26	R2016046	Shijin Lukose	
27	R2014247	Jebin Jogi Mathew	
28	R2014233	Ben Johnson	
29	R2014234	Benjamin Joseph	



30	R2014297	Roby Varghees	
31	R2014	Neil Jose Anthony	
32	R2014253	Jose Philip	
33	R2014285	Ninan Thomas	
34	R2014271	Melbin D Sabu	

DIRECTOR
KOSHY'S INSTITUTE OF MANAGEMENT STUDIES
#31/1, Kadusonnappanahalli,
Kannur Po., Hennur-Bagalur Road,
Bangalore-562 149



KOSHYS

INSTITUTE OF MANAGEMENT STUDIES

NAAC Accredited & ISO 9001 2015 Certified

DEPARTMENT OF COMPUTER APPLICATIONS

Date: 13/06/2023

CIRCULAR

The Department of Computer Applications is organizing a Seminar on "SMART CITIES with IOT" for 2nd, 4th and 6th Semester BCA students on 15th June 2023. All the students should attend this Seminar without fail and gain the knowledge.

Venue: Auditorium

Date: 15th June 2023

Time: 11:00am-01:00pm

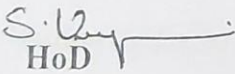
HoD

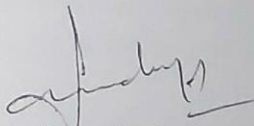
Principal

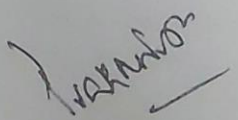
Director
DIRECTOR
KOSHYS INSTITUTE OF MANAGEMENT STUDIES
31/1, Kadusonnappanahalli,
Kannur Po, Hennur-Bagalur Road,
Bengaluru - 560 077





KOSHYS

INSTITUTE OF MANAGEMENT STUDIES

NAAC Accredited & ISO 9001 2015 Certified

Report on Seminar

Topic: " SMART CITIES with IOT "

Date:15/06/2023, Day: Thursday, Time:11:00am- 01:00pm

Preamble: Koshys College, BCA Department took an initiative in conducting seminar on " SMART CITIES with IOT " in order to train and up skill students with various IOT concepts and its application in various cities and also on varied concepts which pays a way towards holistic development.

Speaker's profile: Dr Sashikanth Reddy A, Accomplished IoT specialist with a passion for delivering wearable devices, solutions to security protocols for sensor data, low power energy protocols for microcontroller implementations. Had delivered more than 20 workshops on Internet of Things – Hands on with different ARM based microprocessors and microcontrollers. Has 5 Scopus indexed Q2 publications to my name. Completed research project on developing mobile application to diagnose urticaria diseases funded by DTS. Guided students at Smart India Hackathon competition and team stood among top 10 innovative project for 3 time (in 2017, 2018 & 2019).

Participant's profile: All the 6th, 4th and 2nd semester of BCA students participated.

Description: The Seminar started with giving real time introduction to IOT followed with definition; how IOT are related to real life, how IOT will help to build smart cities in European nations. And also the seminar was focused on The foundation of smart cities relies on the utilization of Internet of Things (IoT) devices and networks. These devices, in combination with software solutions, user interfaces, and communication networks, enable and enhance the functioning and efficiency of smart cities.

Ultimately, the goal is to have IoT technologies interconnected, with data flowing seamlessly between devices, in order to create a truly smart city that can improve quality of life. More specifically, these IoT technologies include radio-frequency identification (RFID), near-field communication (NFC), low-power wide-area (LPWA), wireless telecommunications, wireless sensor network (WSN), DASH7, and addressing.

IoT Technologies for Smart Cities

Radio-frequency identification (RFID) tagging devices use radio frequencies to transfer data, mainly to track and identify objects and people. In a smart city, tracking the location and movement of vehicles, equipment, and even people can generate important data that can be used to optimize the operation of transportation systems, waste collection routes, and parking availability.

Near-field communication (NFC) is a set of standards for smartphones and other devices – like credit card readers – to establish radio communication with each other by bringing them into close proximity, typically within an inch (or a few centimeters). In smart cities, NFC is used for bidirectional short-distance communication, such as contactless payments, access control, and electronic ticketing.

DIRECTOR
KOSHYS INSTITUTE OF MANAGEMENT STUDIES
31/1, Kadusonnappanahalli,
Kannur Po, Hennur-Bagalur Road,
Bangalor-562 149



Low-power wide-area (LPWA), in licensed spectrum, is an optimal solution for IoT applications that require low-power, low-cost, and low-bandwidth communication. At the same time, LPWA technologies benefit from battery life of ~10 years.

In a smart city, LPWA networks are used in applications such as building automation and industrial automation – part of the Industrial Internet of Things (IIoT).

3G, 4G Long-Term Evolution (LTE), and 5G are cellular wireless telecommunications standards that have been primarily used by mobile phones and data terminals. Importantly, 5G offers lower latency, increased speed, higher density (# of connected devices), added capacity (network throughput), and energy efficiency, as compared to prior wireless generations.

A wireless sensor network (WSN) is a network that is untethered to any wires and comprises a large number of small, low-power devices called sensor nodes. Specifically, these nodes are equipped with sensors, microcontrollers, and wireless communication capabilities, and are deployed in a variety of environments to monitor and collect data.

Sir also explained about application like,

1) Smart Urban Mobility

- Traffic Monitoring
- Smart Parking
- Connected Vehicles

2) Urban Sustainability

- Smart Lighting
- Smart Meters
- Smart Waste Management

3) Smart Buildings and Environment

- Air Quality Monitoring
- Building Automation
- Noise Monitoring

The entire program was coordinated with the support of the chairman sir, Dean mam, COO sir, Director sir, Principal mam and faculties of BCA Department for their support for the smooth conduct of the Seminar

Feedback: The Seminar was very Interactive and Informative, students gained knowledge about the IOT devices and there uses in our day to day lives and indeed knowledge in Cities with IOT. Also got good response during the questionnaire session.

Prasanna
DIRECTOR
KOSHYS INSTITUTE OF MANAGEMENT STUDIES
31/1, Kadusonnappanahalli,
Kannur Po, Hennur-Bagalur Road,
Bangalore-562 149



Photo Gallery



KOSHYs
INSTITUTE OF MANAGEMENT STUDIES

Department Of Computer Applications

Organizing a Seminar on

"SMART CITIES with IOT"



Dr. Sashikanth Reddy A MCA, PhD - CS

Research Head, Parvam ConsulTech, Bengaluru
Associate Professor, NITTE Institute of Technology, Bengaluru

Venue: Auditorium | Date: 15th June 2023 | Time: 11:00am-01:00pm

No.31/1, Kannur PO, Hennur-Bagalur Road, Mitganahalli
Kadusonnapanahalli, Bengaluru, Karnataka 562149

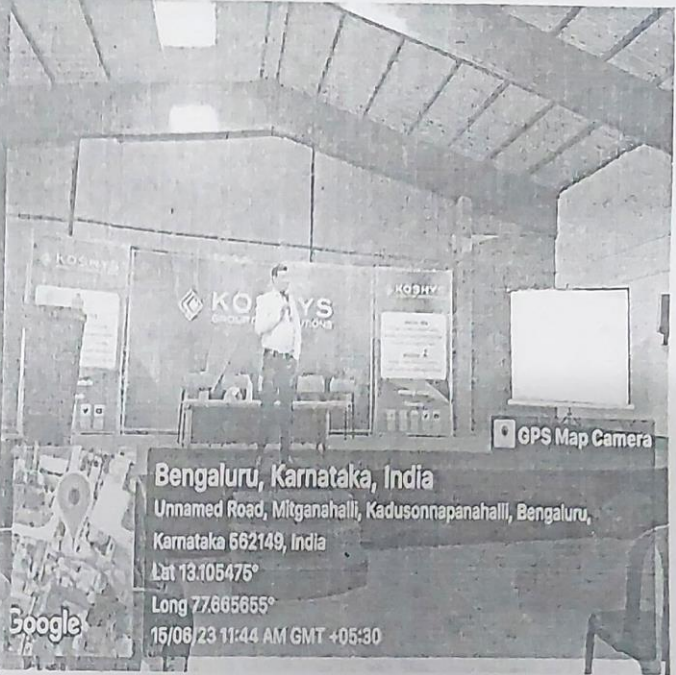
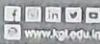

GPS Map Camera

Bengaluru, Karnataka, India

Unnamed Road, Mitganahalli, Kadusonnapanahalli, Bengaluru,
Karnataka 562149, India

Lat 13.105475°

Long 77.865655°

15/08/23 11:44 AM GMT +05:30



GPS Map Camera

Bengaluru, Karnataka, India

Unnamed Road, Mitganahalli, Kadusonnapanahalli, Bengaluru,
Karnataka 562149, India

Lat 13.105465°

Long 77.865661°

15/08/23 11:46 AM GMT +05:30



GPS Map Camera

Bengaluru, Karnataka, India

4M48+65M, Mitganahalli, Kadusonnapanahalli, Bengaluru, Karnataka
562149, India

Lat 13.105638°

Long 77.866426°

15/08/23 11:45 AM GMT +05:30



S. I. Reddy
HoD

[Signature]
Principal

[Signature]
Director

KOSHYs INSTITUTE OF MANAGEMENT STUDIES
31/1, Kadusonnapanahalli,
Kannur Po, Hennur-Bagalur Road
Bengaluru-562 149

Section



KOSHYS

INSTITUTE OF MANAGEMENT STUDIES

NAAC Accredited & ISO 9001 2015 Certified

STUDENT ATTENDANCE LIST

Date: 15/06/2023

Sl No	Register No	Name	Signature
1.	U19BU2250021	Goutham Raj	
2.	U19BU2250005	Rosh K Roy	
3	U19BU2250072	Irfanul Ameen	
4	U19BU220067	Allah CK	
5	U19BU220070	Jithin Prasad	
6.	U19BU2250055	Akhil Sabu	
7	U19BU2250053	Jeevin Johnson	
8	U19BU2250043	Adwaith Aravind	
9	U19BU2250068	Ashwin.S	
10	U19BU2250026	Vaishnav.V	
11	U19BU2250025	Sourav.VS	
12	U19BU2250041	Amal Raj	
13	U19BU2250085	Abhin Thomas	
14	U19BU2250086	Abin Abraham	
15	U19BU2250022	Alex Augusthy	
16	U19BU2250010	Melvin J. Mathew	
17	U19BU2250062	Steehathi.S	
18	U19BU2250078	Yashwanath.V.G	
19.	U19BU2250064	Vishnu.B	
20	U19BU2250046	Bhooath.R	
21.	U19BU2250081	Shubhudu Kanak	
22	U19BU2250044	Jagan.V	
23.	U19BU2250001	Chandhan.K	
24	U19BU2250009	Nithish.V	

DIRECTOR
KOSHYS INSTITUTE OF MANAGEMENT STUDIES
31/1, Kadusonnappanahalli,
Kannur Po, Hennur-Bagalur Road,
Bangalore-562 149





KOSHYS

INSTITUTE OF MANAGEMENT STUDIES

NAAC Accredited & ISO 9001 2015 Certified

2nd sem 'B' sec

STUDENT ATTENDANCE LIST

Date: 15/06/2023

SI No	Register No	Name	Signature
1	U19BU2250090 Abhinav P Anil	Abhinav P. Anil	
2	U19BU2250087	Anwar mubarak E.N	
3	U19BU2250092	AKSHAY DEU JOSI	
4	U19BU2250181	Amal nath .T	
5	U19BU2250145	Sanju Sibi	
6	U19BU2250108	Melvin Sabu	
7	U19BU2250141	Sivaramakrishnan A	
8	U19BU2250152	Rithul Raj k	
9	U19BU2250164	Md. Saleem	
10	U19BU2250122	P. Jibin Anto	
11	U19BU2250111	BHARATH Kumar A	
12	U19BU2250098	Vishal.N	
13	U19BU2250168	Keshor .us	
14	U19BU2250157	P. Nikitha	
15	U19BU2250188	Chethana BN	
16	U19BU2250158	Prakruthi.L	
17	U19BU2250164	Lakshmi.G.	
18	U19BU2250161	Divya.c	
19	U19BU2250106	Noor aysha	
20	U19BU2250162	Vinutha.M	
21	U19BU2250127	Bhavana. N.V	
22	U19BU2250117	Sofiya.M	
23	U19BU2250146	Nandana Rajeev	
24	U19BU2250112	Hasanath	

DIRECTOR
KOSHYS INSTITUTE OF MANAGEMENT STUDIES
31/1, Kadusohannappanahalli,
Kannur Po, Hennur-Bagalur Road,
Bangalore-562 149





KOSHYS

INSTITUTE OF MANAGEMENT STUDIES

NAAC Accredited & ISO 9001 2015 Certified

DEPARTMENT OF BBA (AVIATION MANAGEMENT)

Date: 20/05/2023

Circular

Department is conducting seminar on "Personal and Menstrual Hygiene" on 25/05/2023 at 11:00am in auditorium for all the female students of UG. We cordially invite all the female staffs and students for the same.

HoD

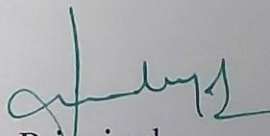
Principal

Director

DIRECTOR
KOSHYS INSTITUTE OF MANAGEMENT STUDIES
31/1, Kadusonnappanahalli,
Kannur Po, Hennur-Bagalur Road,
Bengaluru - 560 077



Report of Seminar on Health Education (SHE) titled
"PERSONAL & MENSTRUAL HYGIENE"

Date: 25th May 2023

Department: B.B.A (Aviation Management)

Venue: KIMS Auditorium

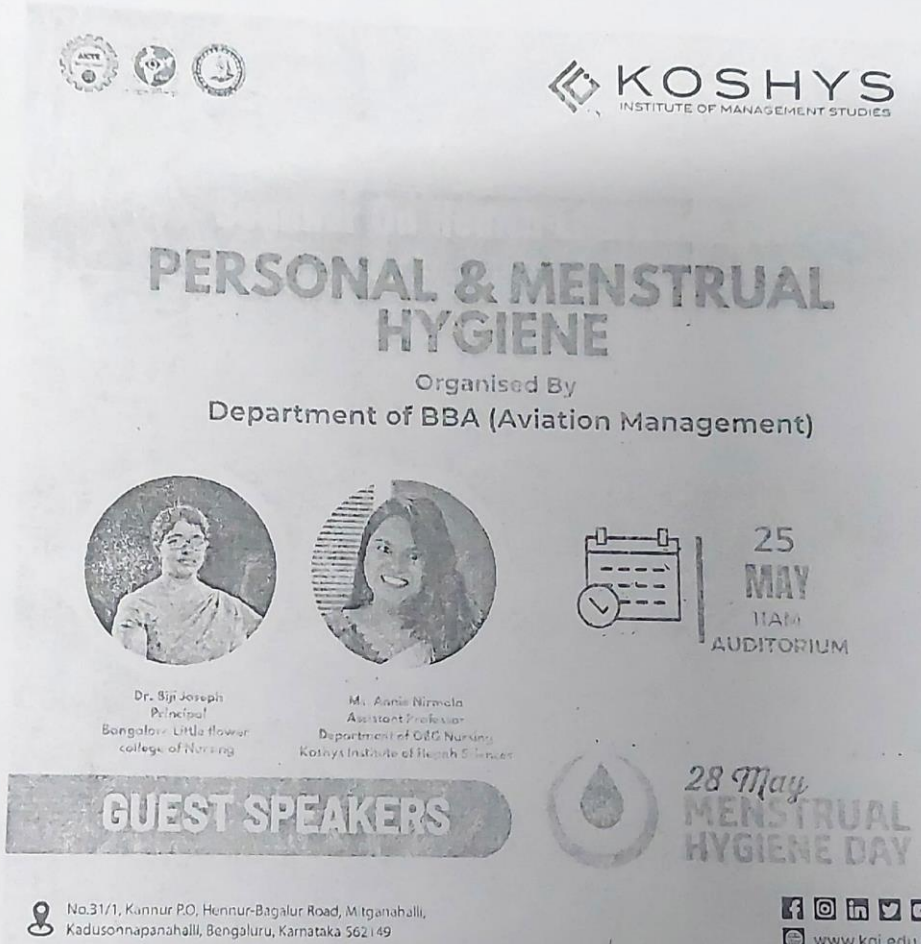

The poster features the KOSHYS logo at the top right and three accreditation logos at the top left. The main title "PERSONAL & MENSTRUAL HYGIENE" is prominently displayed in the center. Below the title, it states "Organised By Department of BBA (Aviation Management)". Two circular portraits of the guest speakers are shown: Dr. Biji Joseph, Principal of Bangalore Little Flower College of Nursing, and Ms. Annie Nirmala, Assistant Professor in the Department of OBG Nursing at KIHS. To the right, a calendar icon indicates the date "25 MAY 11AM AUDITORIUM". At the bottom, a banner reads "GUEST SPEAKERS" and another banner mentions "28 May MENSTRUAL HYGIENE DAY". Contact information for KOSHYS is provided at the bottom left, and social media icons and the website "www.kgi.edu.in" are at the bottom right.

A Seminar was organized on "Personal & MENSTRUAL HYGIENE" by Prof. Biji Joseph, Principal, Bangalore Little flower college of Nursing and Ms. Annie Nirmala, Assistant Professor, Department of OBG Nursing, KIHS. The Seminar was organized by B.B.A (Aviation Management) Department on 25th May 2023 comprising about 250 girls from all the departments of KIMS.

Prasanna
DIRECTOR
KOSHYS INSTITUTE OF MANAGEMENT STUDIES
31/1, Kadusonnappanahalli,
Kannur Po, Hennur-Bagalur Road,
Bangalore-562 149



The Seminar was aimed at educating the students on Maintaining Proper Menstrual Hygiene. As we all know that Proper menstrual hygiene practices contribute to maintaining good health and well-being. It also ensures that students can manage their periods comfortably. Having access to appropriate menstrual products and facilities, such as clean toilets with disposal options, allows them to attend classes, participate in activities, and interact with others without discomfort or embarrassment. This promotes their overall confidence and self-esteem. The guest speaker Ms. Annie Nirmala addressed the topics such as the importance of hygiene practices, dispelling myths and misconceptions, understanding menstrual health, promoting menstrual hygiene management, and creating a supportive environment for women with her presentation.



Pranav
DIRECTOR
KOSHYS INSTITUTE OF MANGEMENT STUDIES
31/1, Kadusonnappanahalli,
Kannur Po, Hennur-Bagalur Road,
Bangalor-562 149





[Handwritten Signature]
Co-ordinator

[Handwritten Signature]
HOD

[Handwritten Signature]
Director
DIRECTOR
KOSHYS INSTITUTE OF MANAGEMENT STUDIES
31/1, Kadusonnappanahalli,
Kannur Po, Hennur-Bagalur Road,
Bengaluru - 560 077



5.1.2

LIFE SKILLS
[YOGA, HEALTH & HYGIENE AND ICT]
[Supporting Documents]

FOR

ACADEMIC YEAR 2021-2022



KOSHYS

INSTITUTE OF MANAGEMENT STUDIES

NAAC Accredited & ISO 9001 2015 Certified

DEPARTMENT OF BCA

Date: 14/06/2022

Circular

As part of our commitment to promote holistic well-being and fostering a healthy lifestyle, we are delighted to announce the celebration of International Yoga Day on June 21, 2022 at 10 AM to 11.30 AM in the auditorium. This event aims to create awareness about the numerous benefits of yoga and provide an opportunity for our college community to embrace this ancient practice.

DIRECTOR
KOSHYS INSTITUTE OF MANAGEMENT STUDIES
31/1, Kadusonnappanahalli,
Kannur Po, Hennur-Bagalur Road,
Bangalore-562 149

DIRECTOR



KOSHYS

INSTITUTE OF MANAGEMENT STUDIES

NAAC Accredited & ISO 9001 2015 Certified

Report on International Yoga Day celebration

Organized By KOSHYS GROUP OF INSTITUTION

[On 21-06-2022, Tuesday 10:00AM to 11:30 AM]

International Yoga Day was celebrated as on 21st June 2022 in the Auditorium at 10 am by the Koshys group of institutions under the guidance of Ashwini P, Assistant Professor, KIMS .

The echoes of collective breaths and the shared commitment to well-being during International Yoga Day have sown the seeds for a culture of self-care within Koshys Group Of Institution. Let this culture blossom, encouraging individuals to prioritize their physical and mental health. In the nurturing environment of our college, may self-care become not just a practice but an ingrained aspect of our community's ethos.

The resounding success of International Yoga Day serves as a testament to the power that lies within the union of mind, body, and spirit. As we witnessed participants embracing various yoga practices, it became evident that the empowerment of the mind inevitably leads to the nurturing of healthy bodies. Let this event be a catalyst for ongoing empowerment and well-being within our college community.

International Yoga Day at Koshys Group Of Institution was not just a celebration of physical postures but a harmonious convergence of

V. Prakash
DIRECTOR
KOSHYS INSTITUTE OF MANAGEMENT STUDIES
31/1, Kadusonnappanahalli,
Kannur Po, Hennur-Bagalur Road,
Bangalore-562 149

diverse individuals seeking balance and well-being. The varied expressions of yoga, from meditative moments to dynamic asanas, showcased the beauty of diversity in our collective journey towards a healthier and more harmonious existence.



[A GLANCE ON YOGA DAY]

Prakashan
DIRECTOR
KOSHYS INSTITUTE OF MANGEMENT STUDIES
31/1, Kadusonnappanahalli,
Kannur Po, Hennur-Bagalur Road,
Bangalor-562 149

DIRECTOR



KOSHYS

INSTITUTE OF MANAGEMENT STUDIES

NAAC Accredited & ISO 9001 2015 Certified

ATTENDENCE SHEET

SL.NO	STUDENT NAMES	SIGNATURE
1	MUKESH	<u>Mukesh</u>
2	Karthik, R	<u>Karthi</u>
3	Varun, K	<u>Varun</u>
4	Jhon S	<u>Jhon</u>
5	Pruthvi	<u>Pruthvi</u>
6	Kashinath, N	<u>Kashin</u>
7	Manu gouda.	<u>Manu</u>
8	Chandan, R	<u>Chandan</u>
9	Harsha	<u>Harsha</u>
10	Mari	<u>Mari</u>
11	Santosh	<u>Santosh</u>
12	Sarju	<u>Sarju</u>
13	Sujatha	<u>Sujatha</u>
14	Munesh	<u>Munesh</u>
15	Puneeth	<u>Puneeth</u>
16	Rejinee	<u>Rejinee</u>
17	Antony Resi	<u>AR</u>
18	wabeem	<u>wabeem</u>
19	Rajesh	<u>Rajesh</u>
20	Santosh	<u>Santosh</u>
21	Naga	<u>Naga</u>
22	Nagaraj	<u>Nagaraj</u>
23	Manju	<u>Manju</u>
24	Marianna	<u>Marianna</u>
25	Keishora	<u>Keishora</u>
26	Arisueth	<u>Arisueth</u>
27	Akshy	<u>Akshy</u>
28	Varshith	<u>Varshith</u>
29		<u>Varshith</u>

Pranav

DIRECTOR
KOSHYS INSTITUTE OF MANAGEMENT STUDIES
31/1, Kadusonnappanahalli,
Kannur Po, Hennur-Bagalur Road,
Bangalore-562 149



CERTIFICATE OF PARTICIPATION

THIS ACKNOWLEDGES THAT

Prasad V

Has participated in the

**“International Yoga Day” held on 21/06/2022 by the department of
BCA**

Principal

DIRECTOR
KOSHYS INSTITUTE OF MANAGEMENT STUDIES
31/1, Kadusonnappanahalli,
Kannur Po, Hennur-Bagalur Road,
Bangalore-562 149

Director

DIRECTOR
KOSHYS INSTITUTE OF MANGEMENT STUDIES
31/1, Kadusonnappanahalli,
Kannur Po, Hennur-Bagalur Road,
Bangalore-562 149



CERTIFICATE OF PARTICIPATION

THIS ACKNOWLEDGES THAT

Saniya K K

Has participated in the

**“International Yoga Day” held on 21/06/2022 by the department of
BCA**

A handwritten signature in blue ink, appearing to read "S. Srinivas", is positioned above the Principal's name.

Principal

An official circular stamp of the Director is located to the left of the Director's name. It contains the text "DIRECTOR" and "KOSHYS INSTITUTE OF MANAGEMENT STUDIES" around the perimeter, with the address "# 31/1, Kadusonnappanahalli, Kannur Po, Hemur-Bagalur Road, Bangalore-562 149" in the center.

Director

A handwritten signature in blue ink, appearing to read "Prasanna", is positioned above the Director's name.

DIRECTOR
KOSHYS INSTITUTE OF MANGEMENT STUDIES
31/1, Kadusonnappanahalli,
Kannur Po, Hemur-Bagalur Road,
Bangalore-562 149



CERTIFICATE OF PARTICIPATION

THIS ACKNOWLEDGES THAT

Adarsh K P

Has participated in the

**“International Yoga Day” held on 21/06/2022 by the department of
BCA**

Deepa

See
DIRECTOR
KOSHYS INSTITUTE OF MANAGEMENT STUDIES
31/1, Kadusonnappanahalli,
Kannur Po, Hennur-Bagalur Road,
Bangalore-562 149

Prakash
DIRECTOR
KOSHYS INSTITUTE OF MANGEMENT STUDIES
31/1, Kadusonnappanahalli,
Kannur Po, Hennur-Bagalur Road,
Bangalore-562 149



CERTIFICATE OF PARTICIPATION

THIS ACKNOWLEDGESTHAT

Devika Manoj

Has participated in the

“International Yoga Day” held on 21/06/2022 by the department of
BCA

Deepa

See
DIRECTOR
KOSHY'S INSTITUTE OF MANAGEMENT STUDIES
31/1, Kadusonnappanahalli,
Kannur Po, Hennur-Bagalur Road,
Bangalore-562 149

Prakash
DIRECTOR
KOSHY'S INSTITUTE OF MANAGEMENT STUDIES
31/1, Kadusonnappanahalli,
Kannur Po, Hennur-Bagalur Road,
Bangalore-562 149



CERTIFICATE OF PARTICIPATION

THIS ACKNOWLEDGESTHAT

Vishnavi A

Has participated in the

**“International Yoga Day” held on 21/06/2022 by the department of
BCA**

Deepa

See
DIRECTOR
KOSHYS INSTITUTE OF MANAGEMENT STUDIES
31/1, Kadusonnappanahalli,
Kannur Po, Hennur-Bagalur Road,
Bangalore-562 149

Prasanna
DIRECTOR
KOSHYS INSTITUTE OF MANAGEMENT STUDIES
31/1, Kadusonnappanahalli,
Kannur Po, Hennur-Bagalur Road,
Bangalore-562 149



KOSHYS

INSTITUTE OF MANAGEMENT STUDIES

NAAC Accredited & ISO 9001 2015 Certified

DEPARTMENT OF BCA

Date: 14/09/2022

Circular

This is to inform that Department of BCA is conducting two-days boot camp workshop for “Selenium Testing” for second year BCA students on 20th September,2022 in the seminar hall. Participation is compulsory for everyone.

Prasanna
DIRECTOR
KOSHYS INSTITUTE OF MANAGEMENT STUDIES
31/1, Kadusonnappanahalli,
Kannur Po, Hennur-Bagalur Road,
Bangalore-562 149

DIRECTOR



KOSHYS

INSTITUTE OF MANAGEMENT STUDIES

NAAC Accredited & ISO 9001 2015 Certified

REPORT

The Two-Day Selenium Testing Boot Camp Workshop conducted by Souraj Prabhakaran of TechCentrix provided participants with a condensed and immersive learning experience in Selenium testing. The combination of theoretical knowledge, hands-on labs, and exposure to industry best practices contributed to a well-rounded and impactful workshop.

Based on participant feedback, future boot camps could explore more advanced topics in Selenium testing, such as integration with testing frameworks (e.g., TestNG, JUnit), parallel test execution, and cross-browser testing.

Throughout the workshop, participants were introduced to industry best practices in Selenium testing. Topics included test case organization, test data management, and integrating Selenium into a continuous integration/continuous deployment (CI/CD) pipeline.

The workshop heavily emphasized hands-on learning through labs, coding challenges, and practical exercises. Participants engaged in real-world scenarios, applying Selenium concepts to build automated test scripts and solve testing challenges.

DIRECTOR
KOSHYS INSTITUTE OF MANAGEMENT STUDIES
31/1, Kadusonnappanahalli,
Kannur Po, Hennur-Bagalur Road,
Bangalore-562 149



Praxitron
DIRECTOR
KOSHYS INSTITUTE OF MANGEMENT STUDIES
31/1, Kadusonnappanahalli,
Kannur Po, Hennur-Bagalur Road,
Bangalor-562 149

DIRECTOR

CERTIFICATE

— OF PARTICIPATION —

This is to Certify That

CHANDHU

This is a certify that Chandhu has participated in the Two day Boot Camp Workshop on Selenium Testing held at koshy's Institute of management studies from 20th to 21th September 2022



Prof. Sandhya S
Principal



Dr. Prakash B Nayak
Director

DIRECTOR
KOSHYS INSTITUTE OF MANGEMENT STUDIES
31/1, Kadusonnappannahalli,
Kannur Po, Hennur-Bagalur Road,
Bangalor-562 149

CERTIFICATE

— OF PARTICIPATION —

This is to Certify That

SUPRIYA M

This is a certify that Supriya M has participated in the Two day BootCamp Workshop on Selenium Testing held at koshy's Institute of management studies from 20th to 21th September 2022



Prof. Sandhya S
Princip al



Dr. Prakash B Nayak
Director

DIRECTOR
KOSHYS INSTITUTE OF MANGEMENT STUDIES
31/1, Kadusonnappanahalli,
Kannur Po, Hennur-Bagalur Road,
Bangalor-562 149



Software Testing

Praxan
DIRECTOR
KOSHYS INSTITUTE OF MANGEMENT STUDIES
31/1, Kadusonnappanahalli,
Kannur Po, Hennur-Bagalur Road,
Bangalor-562 149



Objective

The objective of this presentation is to show the

- How to define Software Testing Principles
- What are the types of Software Tests
- What is Test Planning

- Test Execution and Reporting
- Real-Time Testing

How to define Software



Testing Principles

Prakash
DIRECTOR
KOSHY'S INSTITUTE OF MANAGEMENT STUDIES
31/1, Kadusonnappanahalli,
Kannur Po, Hennur-Bagalur Road,
Bangalore-562 149

- **Testing**
The execution of a program to find its faults
- **Verification**
The process of proving the programs correctness.
- **Validation**
The process of finding errors by executing the program in a real environment
- **Debugging**
Diagnosing the error and correct it



Software Testing Principles

- To remove as many defects as possible before test since the quality improvement potential of testing is limited

Prakash
DIRECTOR
KOSHYS INSTITUTE OF MANAGEMENT STUDIES
31/1, Kadusonnappanahalli,
Kannur Po, Hennur-Bagalur Road,
Bangalore-562 149

What are the Types of Software Tests

- Unit Testing (White Box)
- Integration Testing
- Function Testing (Black Box)
- Regression Testing
- System Test
- Acceptance and Installation Tests

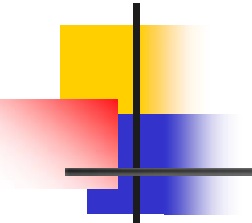

Unit Testing (White Box)

- Individual components are tested.
- It is a path test.
- To focus on a relatively small segment of code and aim to exercise a high percentage of the internal path
- Disadvantage: the tester may be biased by previous experience. And the test value may not cover all possible values.



Integration Testing

- Top-down Integration Test
- Bottom-up Integration Test

Prakashan
DIRECTOR
KOSHYS INSTITUTE OF MANAGEMENT STUDIES
31/1, Kadusonnappanahalli,
Kannur Po, Hennur-Bagalur Road,
Bangalore-562 149



Top-down Integration Test

Prakashan
DIRECTOR
KOSHYS INSTITUTE OF MANAGEMENT STUDIES
31/1, Kadusonnappanahalli,
Kannur Po, Hennur-Bagalur Road,
Bangalore-562 149

- The control program is tested first. Modules are integrated one at a time. Emphasize on interface testing
 - Advantages: No test drivers needed Interface errors are discovered early Modular features aid debugging
 - Disadvantages: Test stubs are needed

Errors in critical modules at low levels are found late.

Top-down Testing

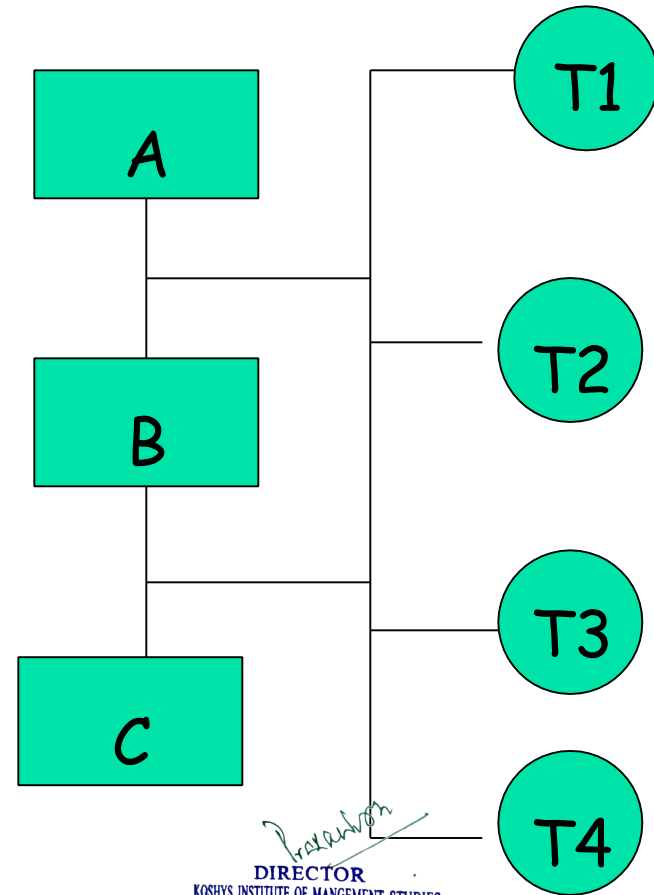
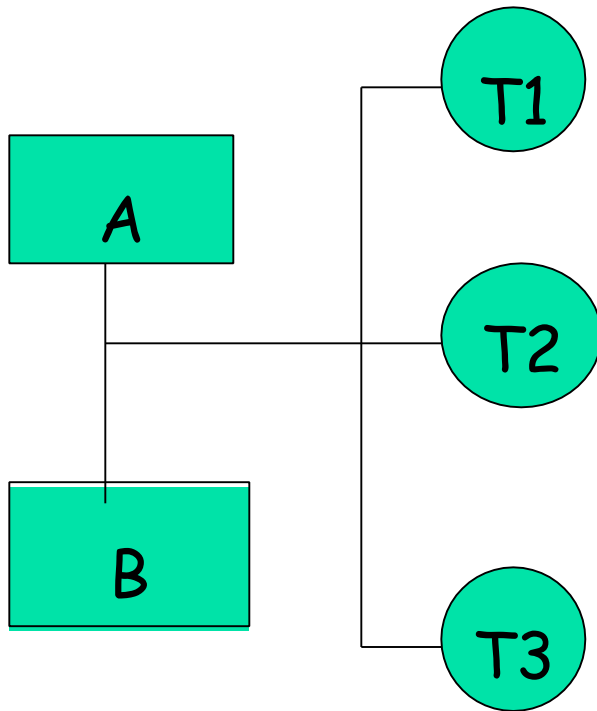



Bottom-up Integration Test

- Allow early testing aimed at proving feasibility
Emphasize on module functionality and performance
- Advantages: No test stubs are needed

Errors in critical modules are found early

- Disadvantages: Test drivers are needed

Interface errors are discovered late

Praxan

DIRECTOR
KOSHYS INSTITUTE OF MANGEMENT STUDIES
31/1, Kadusonnappanahalli,
Kannur Po, Hennur-Bagalur Road,
Bangalor-562 149

Bottom-up testing

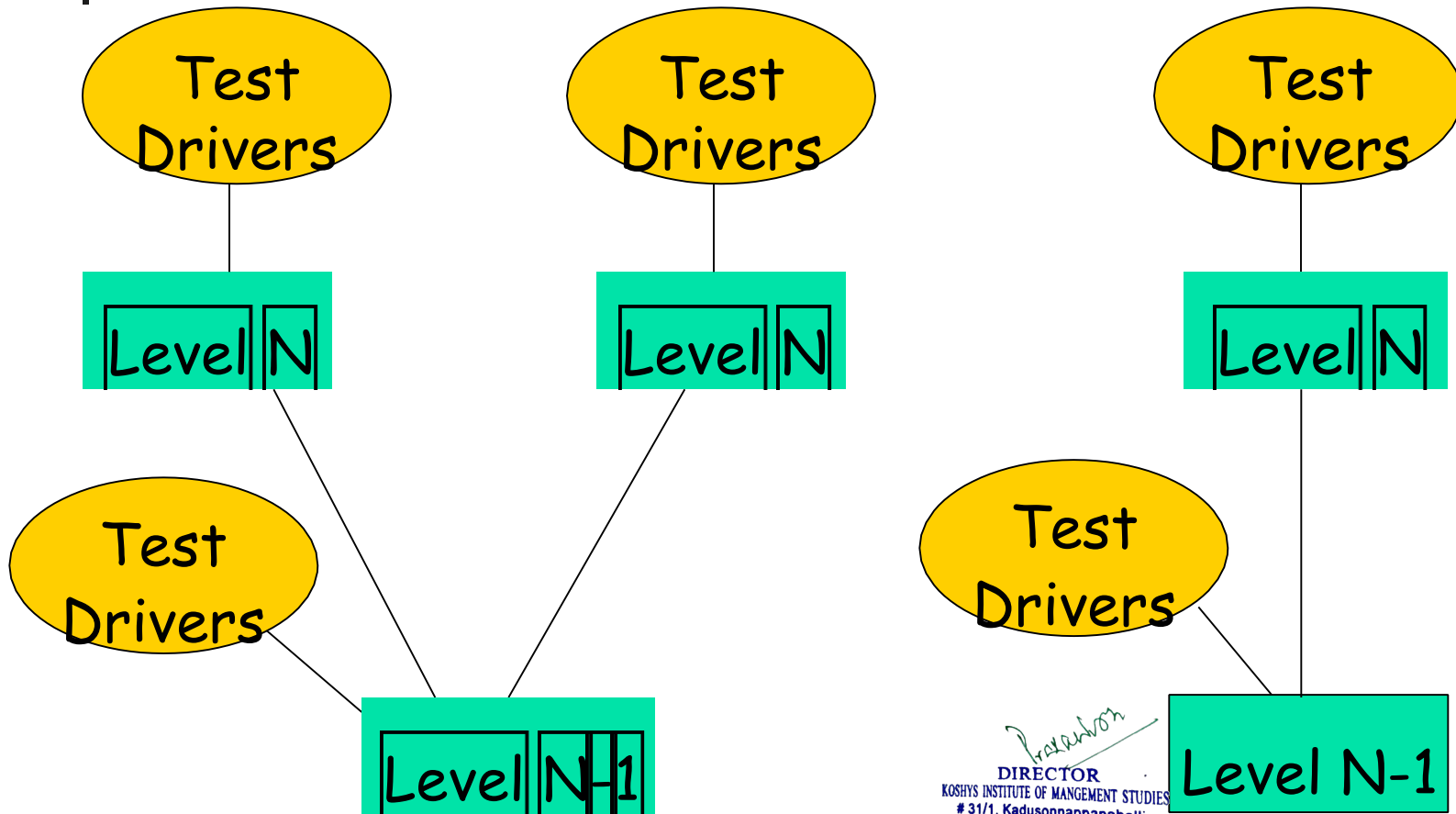



Function Testing (Black Box)

- Designed to exercise the to its external specifications
- Testers not biased by knowledge of the program's design.
- Disadvantages:
 1. The need for explicitly stated requirements

2. Only cover a small portion of the possible test conditions.



Regression Testing

Prakash
DIRECTOR
KOSHYS INSTITUTE OF MANAGEMENT STUDIES
31/1, Kadusonnappanahalli,
Kannur Po, Hennur-Bagalur Road,
Bangalore-562 149

- Test the effects of the newly introduced changes on all the previously integrated code.
- The common strategy is to accumulate a comprehensive regression bucket but also to define a subset.
- The full bucket is run only occasionally, but the subset is run against every spin.
- Disadvantages:
 1. To decide how much of a subset to use and which tests to select.



What is Test Planning

- Define the functions, roles and methods for all test phases.
- Test planning usually start during the requirements phase.
- Major test plan elements are:
 1. Objectives for each test phase
 2. Schedules and responsibilities for each test activity
 3. Availability of tools, facilities and test libraries.

4. Set the criteria for test completion

Prakashan
DIRECTOR
KOSHYS INSTITUTE OF MANGEMENT STUDIES
31/1, Kadusonnappanahalli,
Kannur Po, Hennur-Bagalur Road,
Bangalor-562 149



Test Execution & Reporting

- Testing should be treated like an experiment.
- Testing require that all anomalous behavior be noted and investigated.
- Big companies keep a special library with all copies of test reports, incident forms, and test plans



Real-Time Testing

- Real-Time testing is necessary because the deployment system is usually more complicated than development system
- Rules apply for testing real time system
 1. Evaluate possible deadlocks, thrashing to special timing conditions
 2. Use tests to simulate hardware faults.
 3. Use hardware simulation to stress the software design.

4. Design ways to simulate modules missing in the development system.



References

- DeMillo, Software Testing and Evaluation Benjamin/Cummings Publishing Company, Inc California, 1987.
- Sommerville, Software Engineering

- Addison-Wesley Publishing Company, 1996
- Humphrey, Managing the Software Process, Addison-Wesley Publishing Company, 1990.

Prakash
DIRECTOR
KOSHYS INSTITUTE OF MANGEMENT STUDIES
31/1, Kadusonnappanahalli,
Kannur Po, Hennur-Bagalur Road,
Bangalor-562 149



KOSHYS

INSTITUTE OF MANAGEMENT STUDIES

NAAC Accredited & ISO 9001:2015 Certified

ATTENDANCE SHEET

SL.NO	STUDENT NAMES	SIGNATURE
1	Abis Bineeth	
2	Aswanth P	
3	Hudarfa Majeed	
4	Jerin George	
5	Adidev A	
6	Bunshad	
7	Anand CS	
8)	Aravind	
9	Abhijith Krishna	
10	K Jay	
11	Abhinav	
12	Rahul	
13	Ceena	
14	Avani	
15	Renuthy	
16	Thertha	
17	Ann G Mathew	
18	Celestin	
19	Rajiv	
20	Aswathy	
21	Pavithra	
22	Anshad	
23	Anzil	
24	Ashad	
25	Raymond	
26	Ajay	
27	Sunilkumar	
28.	Adithyan Suresh	

DIRECTOR
KOSHYS INSTITUTE OF MANAGEMENT STUDIES
#31/1, Kadusonnappanahalli,
Kannur Po, Hennur-Bagalur Road,
Bangalore-562 149



KOSHYS

INSTITUTE OF MANAGEMENT STUDIES

NAAC Accredited & ISO 9001 2015 Certified

DEPARTMENT OF MBA

Date: 03/04/2022

Circular

We are pleased to announce the celebration of World Health Day at our esteemed institution. This year, in honour of this significant occasion, we are organizing a seminar on World Health Day held on 8th April 2022 in the seminar hall. All the students and staffs are welcomed for the same

DIRECTOR
KOSHYS INSTITUTE OF MANAGEMENT STUDIES
31/1, Kadusonnappanahalli,
Kannur Po, Hennur-Bagalur Road,
Bangalore-562 149

DIRECTOR

Report of talk on “WORLD HEALTH DAY”

Date: 08/04/2022

Department: MBA

Venue: KIMS Auditorium



WORLD HEALTH DAY – was celebrated on 08th April 2022 by MBA

students under the guidance of the SNA advisors. The main objective was to raise awareness about the ongoing health issues and overall wellbeing of the society. An awareness rally was conducted by the student. Students took part in poster competitions. To end the program there was planting of “SAPLINGS” in recognition of World Health Day.

World Health Day serves as a reminder of the importance of prioritizing health and well-being globally. This year's celebrations were successful in creating posters. Moving forward, it is essential to continue advocating for mental health support, disease prevention and control to ensure a healthier future for all.

DIRECTOR
KOSHYS INSTITUTE OF MANGEMENT STUDIES
31/1, Kadusonnappanahalli,
Kannur Po, Hennur-Bagalur Road,
Bangalor-562 149

DIRECTOR



KOSHYS

INSTITUTE OF LEADERSHIP & MANAGEMENT STUDIES

NAAC Accredited & ISO 9001:2015 Certified

ATTENDANCE SHEET

SL.NO	STUDENT NAMES	SIGNATURE
1	Aksha	Aksha
2	Gagana.V	Gagana.V
3	Chandana.V	Chandana.V
4	Asha.U	Asha.U
5	Deepa.S	Deepa.S
6	Alphin Antony	Alphin Antony
7	Amaljith M.P	Amaljith M.P
8	Girish Krishna K.S.	Girish Krishna K.S.
9	ASWIN MB	ASWIN MB
10	Jibin.G.Ji.Ji	Jibin.G.Ji.Ji
11	Jephine Correya	Jephine Correya
12	Devalat.V.prasad	Devalat.V.prasad
13	Ananthakrishna V.Neil	Ananthakrishna V.Neil
14	Jishnu.G.Nair	Jishnu.G.Nair
15	Amaljith M.S	Amaljith M.S
16	Benson Thomas	Benson Thomas
17	Bisha	Bisha
18	Habeebul Rahman	Habeebul Rahman
19	Goutham	Goutham
20	Jesin Jesome Justin	Jesin Jesome Justin
21	Lional Messi	Lional Messi
22	Rajappan	Rajappan
23	Trukku	Trukku
24	Sunclaran	Sunclaran
25	Chandran	Chandran
27	APPUKUTAN	APPUKUTAN
28	Vs Raju	Vs Raju
49	Bheem	Bheem

Pravankon
DIRECTOR
KOSHYS INSTITUTE OF MANGEMENT STUDIES
31/1, Kadusonnappanahalli,
Kannur Po, Hennur-Bagalur Road,
Bangalore-562 149

30	Kumar	Kumar
31	Muni	Muni
32	Ghariz CSU 22	Ghariz
33	Nandhana	Nandhana
34	Jayasuya	Jayasuya
35	paithurisej	paithurisej
36	^k Sugumaran	Sugumaran
37	Joyal	Joyal
38	Tony	Tony
39	Kishor	Kishor
40	Ronaldo	Ronaldo
41	Alan paul	Alan paul
42	Alan Raj	Alan Raj
43	Raman	Raman
44	Lalu	Lalu
45	Keerthi	Keerthi
46	Zayo	Zayo
47	Celina	Celina
49	Aswathy Achu	Aswathy Achu
50	Neethu Sunil	Neethu Sunil

CERTIFICATE OF APPRECIATION

THIS ACKNOWLEDGES THAT

Shine P S

Has participated in the

**Health & Hygiene program focused on “World Health Day” held on
08/04/2022 by the department of MBA**



Principal



DIRECTOR
KOSHY'S INSTITUTE OF MANAGEMENT STUDIES
3171, Keddionnappanahalli,
Kannur Po, Hennur-Bagalpur Road,
Bangalore-560 149

Director

CERTIFICATE OF APPRECIATION

THIS ACKNOWLEDGES THAT

Joshin Jacob

Has participated in the

**Health & Hygiene program focused on “World Health Day” held on
08/04/2022 by the department of MBA**



Principal



DIRECTOR
KOSHY'S INSTITUTE OF MANAGEMENT STUDIES
311, Keddannappanahalli,
Kannur Po, Hennur-Biggalur Road,
Bangalore-560 149

Director

CERTIFICATE OF APPRECIATION

THIS ACKNOWLEDGES THAT

K M Muskin

Has participated in the

**Health & Hygiene program focused on “World Health Day” held on
08/04/2022 by the department of MBA**



Principal



DIRECTOR
KOSHY'S INSTITUTE OF MANAGEMENT STUDIES
3171, Keddionnappanahalli,
Kannur Po, Hennur-Bagalpur Road,
Bangalore-560 149

Director

CERTIFICATE OF APPRECIATION

THIS ACKNOWLEDGES THAT

Ashitha K

Has participated in the

**Health & Hygiene program focused on “World Health Day” held on
08/04/2022 by the department of MBA**



Principal



DIRECTOR
KOSHY'S INSTITUTE OF MANAGEMENT STUDIES
311, Kedaonnappanahalli,
Kannur Po, Hennur-Biggalur Road,
Bangalore-560 149

Director

CERTIFICATE OF APPRECIATION

THIS ACKNOWLEDGES THAT

Anju U

Has participated in the

**Health & Hygiene program focused on “World Health Day” held on
08/04/2022 by the department of MBA**



Principal



DIRECTOR
KOSHY'S INSTITUTE OF MANAGEMENT STUDIES
3171, Keddionnappanahalli,
Kannur Po, Hennur-Bagalpur Road,
Bangalore-560 149

Director



KOSHYS
INSTITUTE OF MANAGEMENT STUDIES

NAAC Accredited & ISO 9001 2015 Certified

DEPARTMENT OF MBA

Date: 20/10/2021

Circular

We are pleased to inform you about an upcoming seminar on Health and Hygiene, specifically dedicated to raising awareness about breast cancer. We warmly encourage both students and staff to join us for this important event scheduled for October 26th, 2021, at 11 am in the auditorium.

Please note that attendance is voluntary.

DIRECTOR
KOSHYS INSTITUTE OF MANGEMENT STUDIES
31/1, Kadusonnappanahalli,
Kannur Po, Hennur-Bagalur Road,
Bangalore-562 149

DIRECTOR



KOSHYS

INSTITUTE OF MANAGEMENT STUDIES

NAAC Accredited & ISO 9001 2015 Certified

Date: 26/10/2021

Report on Breast Cancer Awareness

The event "Breast Cancer Awareness" aimed to educate young girls and women about the importance of early cancer detection, facilitating easier treatment and better outcomes. On October 26th, 2021, under the theme "ETHNIC PINK OUT" - WALKATHON/WARRIOR CHALLENGE, hosted by Dr. Poivamma C U, Senior Consultant and Director of Breast Oncology at IMA Women's Wing Yelahanka, our college received an invitation to attend and participate. Representing our institution, MBA students joined the walkathon at Allasandra Lake, Main Gate, Yelahanka, and also presented a flash mob performance. They were accompanied by Mrs. Gilly, the nursing supervisor from Cyte Care Hospital. Through this experience, the students gained valuable insights into breast cancer awareness.



[A Glimpse of the day where students were spreading the awareness on breast cancer in the class rooms]

Prakash
DIRECTOR
KOSHYS INSTITUTE OF MANAGEMENT STUDIES
31/1, Kadusonnappanahalli,
Kannur Po, Hennur-Bagalur Road,
Bangalore-562 149
DIRECTOR



KOSHYS
INSTITUTE OF MANAGEMENT STUDIES

NAAC Accredited & ISO 9001 2015 Certified

ATTENDANCE SHEET

SL.NO	NAME	SEMESTER	ATTENDANCE
1	ADARSH	II	P
2	RAZEEN NASAR	II	A
3	ATHIRA NAIR	II	A
4	MOHAMMED MUBEEN VM	II	P
5	MUHAMMED HASHIR M M	II	P
6	MUHAMMED M T	II	P
7	NIHAM SHAMIL M	II	P
8	SHANS BOBAN	II	P
9	ALEN STANLY	II	P
10	DHEERAJ LAL	II	P
11	GOKUL R RAJ	II	P
12	IRSHAD	II	P
13	MUHAMMED FADI INAS	II	P
14	MUHAMMED UNAIS	II	P
15	NAVEEN N	II	P
16	SHIBIL SHIHAB	II	P
17	SANANDU MS	II	P
18	NIKHIL VALIYAPUTHUSERIL SHAJI	II	P
19	MEGHA BABU	II	P
20	MUHAMMED SAHAL PK	II	P
21	RINCHU K	II	P
22	SIMIN THOMAS	II	P
23	ZAIBA AFREEN	II	P
24	SOHAN V S	II	P
25	VARSHITH V	II	P
26	S SANYO RITA	II	P
27	VAMSHI R	II	P
28	UJWALA B	II	P
29	SYED SARVAR AHMED	II	P
30	SHARON CHRISTIN	II	P
31	SREENIDHI	II	P
32	SUDHI SHAJI	II	P
33	SREEHARI KV	II	P
34	SALAHUDEEN AYOوبي YP	II	P
35	YADHUKRISHNA K	II	P
36	VIPIN KRISHNA	II	P
37	SAYOOJ SUNIL	II	P
38	SURYAJITH KM	II	P
39	YAYATHI V M	II	P

Kavayon
DIRECTOR
KOSHYS INSTITUTE OF MANAGEMENT STUDIES
#3171, Kadusonnappanahalli,
Kannur Po, Hennur-Bagalur Road,
Bangalore-562 149

40	SABIN JERONCE	II	A
41	SEBIN MATHEW	II	P
42	RUBIN P RENI	II	A
43	VP SREESIVA	II	P

Jeronce
DIRECTOR
KOSHY'S INSTITUTE OF MANAGEMENT STUDIES
31/1, Kadusonnappanahalli,
Kannur Po, Hennur-Bagalur Road,
Bangalore-562 149

DIRECTOR

5.1.2

LIFE SKILLS

[YOGA, HEALTH & HYGIENE AND ICT]

[Supporting Documents]

FOR

ACADEMIC YEAR 2020-2021

DIRECTOR
KOSHY'S INSTITUTE OF MANAGEMENT STUDIES
31/1, Kadusonnappanahalli,
Kannur Po, Hennur-Bagalur Road,
Bangalore-562 149



KOSHYS

INSTITUTE OF MANAGEMENT STUDIES

NAAC Accredited & ISO 9001 2015 Certified

DEPARTMENT OF BCom

Date: 14/06/2021

Circular

As part of our commitment to promoting holistic well-being and fostering a healthy lifestyle, we are delighted to announce the celebration of International Yoga Day on June 21, 2021 at 10 AM to 11.30 AM through Skype. This event aims to create awareness about the numerous benefits of yoga and provide an opportunity for our college community to embrace this ancient practice.

Prakashan
DIRECTOR
KOSHYS INSTITUTE OF MANAGEMENT STUDIES
31/1, Kadusonnappanahalli,
Kannur Po, Hennur-Bagalur Road,
Bangalore-562 149

Director

Report on International Yoga Day celebration

Organized By

KOSHYS GROUP OF INSTITUTIONS

[On 21-06-2021, Monday 10:00AM to 11:30 AM]

International Yoga Day was celebrated as on 21st June 2021 in the Auditorium at 10 am by the Koshys group of institutions under the guidance of Naveen Kumar, Assistant Professor, KIMS.

As we bid farewell to the echoes of "Om" and the shared moments of tranquility, let our hearts be filled with gratitude for the collective energy that permeated [College Name] on International Yoga Day. In the spirit of unity and well-being, let us carry forward the lessons learned on the mat into the tapestry of our daily lives. Together, we stand, united by breath and bound by a commitment to a healthier, more balanced existence.

The International Yoga Day celebration at Koshys Group Of Institution was a resounding success, fostering a sense of unity and well-being among the college community. The event not only provided valuable knowledge about the ancient practice of yoga but also encouraged individuals to embrace a healthier lifestyle. The overwhelming participation and positive feedback reflect the growing interest in incorporating yoga into the daily routines of the college community.

The success of International Yoga Day lies not just in the vibrancy of the celebration but in the spark it ignites within each participant. Let this event be a catalyst for a sustained yoga practice, a daily commitment to the mat, and a journey towards physical and mental harmony. May the sun salutations of today be the dawn of a new era of wellness in our college community.



Prasanna
DIRECTOR
KOSHYS INSTITUTE OF MANAGEMENT STUDIES
31/1, Kadusonappanahalli,
Kannur Po, Hennur-Bagalur Road,
Bangalore-562 149

DIRECTOR



KOSHYS
INSTITUTE OF MANAGEMENT STUDIES

NAAC Accredited & ISO 9001 2015 Certified

ATTENDANCE LIST

SL.NO	STUDENT NAMES	SIGNATURE
1	Raman S	R
2	Shwathi veermp	S
3	Anatya vijay	A
4	Ankey Anoo	A
5	Anand Kumar	A
6	Vishal R	V
7	Joby	J
8	Aleena CR	A
9	Mathew Jose	M
10	Sibi greg	S
11	Maria EM	M
12	Aneena	A
13	Sonu Sanu	S
14	Jephy	J
15	mini Jose	M
16	Jomi	J
17	Jose	J
18	Ashisi	A
19	Abi	A
20	Joman	J
21	Bibin	B
22	mina	M
23	pyian	P
24	Beno Biju	B
25	Joyel	J
26	Arran	A
27	Joel	J
28	Silvia	S

 DIRECTOR
 KOSHS INSTITUTE OF MANAGEMENT STUDIES
 # 31/1, Kaduonnappanahalli,
 Kannur Po, Hennur-Bagalur Road,
 Bangalor-562 149



KOSHYSTM

INSTITUTE OF MANAGEMENT STUDIES

AFFILIATED TO BENGALURU NORTH UNIVERSITY

CERTIFICATE OF PARTICIPATION

THIS ACKNOWLEDGES THAT

Sanjay V

Has participated in the

**“International Yoga Day” held on 21/06/2021 by the department of
BCom**

Principal

Director

DIRECTOR
KOSHYS INSTITUTE OF MANGEMENT STUDIES
31/1, Kadusonnappanahalli,
Kannur Po, Hennur-Bagalur Road,
Bangalor-562 149



KOSHYS
INSTITUTE OF MANAGEMENT STUDIES

NAAC Accredited & ISO 9001 2015 Certified

DEPARTMENT OF BCA

Date: 14/03/2021

Circular

This is to inform that Department of BCA is conducting two-days boot camp workshop for “Frontend Development” for second year BCA students on 20th March, 2021 in the seminar hall. Participation is compulsory for everyone.

P. Prashanth
DIRECTOR
KOSHYS INSTITUTE OF MANAGEMENT STUDIES
31/1, Kadusonnappanahalli,
Kannur Po, Hennur-Bagalur Road,
Bangalore-562 149

DIRECTOR



KOSHYS

INSTITUTE OF MANAGEMENT STUDIES

NAAC Accredited & ISO 9001 2015 Certified

REPORT

The boot camp workshop was designed to meet the demand for skilled frontend developers by offering participants a comprehensive and practical understanding of frontend technologies. Over the course of two days, participants delved into key concepts, tools, and best practices in frontend development with the help of Athul Bhaskar, Senior Software Engineer, Well Thought Technologies.

The Two-Day Frontend Development Boot Camp Workshop provided participants with a focused and immersive learning experience. The combination of theoretical knowledge, practical exercises, and exposure to industry best practices contributed to a well-rounded and impactful workshop.

Feedback from participants was positive overall. Attendees appreciated the practical nature of the workshop, the relevance of the topics covered, and the opportunity to work on real-world projects. Many expressed confidence in their ability to apply the skills learned in their professional work.

Throughout the workshop, participants were introduced to industry best practices in frontend development. Topics included version control (e.g., Git), code optimization, and collaborative development workflows to prepare them for real-world development environments.

DIRECTOR
KOSHYS INSTITUTE OF MANAGEMENT STUDIES
31/1, Kadusonnappanahalli,
Kannur Po, Hennur-Bagalur Road,
Bangalore-562 149

DIRECTOR

10 SKILLS EVERY FRONT END DEVELOPER NEEDS



1. Html/CSS
2. Javascript
3. CSS And Javascript Frameworks
4. CSS Preprocessing
5. Version Control/Git
6. Responsive Design
7. Testing/Debugging
8. Browser Developer Tools
9. Web Performance
10. Interpersonal Skills



Prasanth
DIRECTOR
KOSHYS INSTITUTE OF MANGEMENT STUDIES
31/1, Kadusonnappanahalli,
Kannur Po, Hennur-Bagalur Road,
Bangalor-562 149

DIRECTOR

CERTIFICATE

— OF PARTICIPATION —

This is to Certify That

NADIR

This is a certify that Nadir has participated in the Two day Boot Camp Workshop on Frontend Development held at koshy's Institute of management studies from 20th to 21th March 2021



Prof. Sandhya S
Principal



Dr. Prakash B Nayak
Director

DIRECTOR
KOSHYS INSTITUTE OF MANGEMENT STUDIES
31/1, Kadusonnappanahalli,
Kannur Po, Hennur-Bagalur Road,
Bangalor-562 149

CERTIFICATE

— OF PARTICIPATION —

This is to Certify That

NANU GOWDA

This is a certify that Nanu has participated in the Two day Boot Camp Workshop on Frontend Development held at koshy's Institute of management studies from 20th to 21th March 2021



Prof. Sandhya S
Princip al



Dr. Prakash B Nayak
Director

DIRECTOR
KOSHYS INSTITUTE OF MANGEMENT STUDIES
31/1, Kadusonnappanahalli,
Kannur Po, Hennur-Bagalur Road,
Bangalor-562 149



StudyMafia.Org

Web-Development



Prashant
DIRECTOR
KOSHS INSTITUTE OF MANAGEMENT STUDIES
81/1, Kadusonnappanahalli,
Kannur Po, Hennur-Bagalur Road,
Bangalore-562 149



Table Contents

- Definition
- Introduction
- Classification
- Frontend Roadmap
- Backend Roadmap
- Full-Stack Developer
- What does Developer do?
- Tools Used
- Conclusion

Kannan
DIRECTOR
KOSHS INSTITUTE OF MANAGEMENT STUDIES
81/1, Kadusonnappanahalli,
Kannur Po, Hennur-Bagalur Road,
Bangalore-562 149

Definition

The word Web Development is made up of two words:

- **Web:** It refers to websites, web pages or anything that works over the internet.
- **Development:** Building the application from scratch.



Introduction

- Web development refers to the building, creating, and maintaining of websites. It includes aspects such as web design, web publishing, web programming, and database management.
- It is the creation of an application that works over the internet i.e. websites.
- The term development is usually reserved for the actual construction of these things (that is to say, the programming of sites). The basic tools involved are programming languages called HTML (Hypertext Markup Language), CSS (Cascading Style Sheets), and JavaScript.

WEB DEVELOPMENT

The Challenges of Web Development

Client Expectations



Unclear Requirements



Security Measures



Website Launch



THUS's Web Development Services

Analytics Interpretation and Reporting



Monitoring Competition



HTML E-mail Template Design



Blog Customization/Management



Pay-Per-Click Campaign Management



Testing



Benefits of Web Development Services



Uniqueness



Quality@Speed



Security



Scalability and Flexibility



Kannan

DIRECTOR
KORUS INSTITUTE OF MANAGEMENT STUDIES
81/1, Kadusonnappanahalli,
Kannur Po, Hennur-Bagalur Road,
Bangalore-662 149

Classification

Web Development can be classified into two ways:

- **Frontend Development:** The part of a website that the user interacts directly is termed as front end. It is also referred to as the 'client side' of the application.
- **Backend Development:** Backend is the server side of a website. It is the part of the website that users cannot see and interact. It is the portion of software that does not come in direct contact with the users. It is used to store and arrange data.

Frontend Roadmap

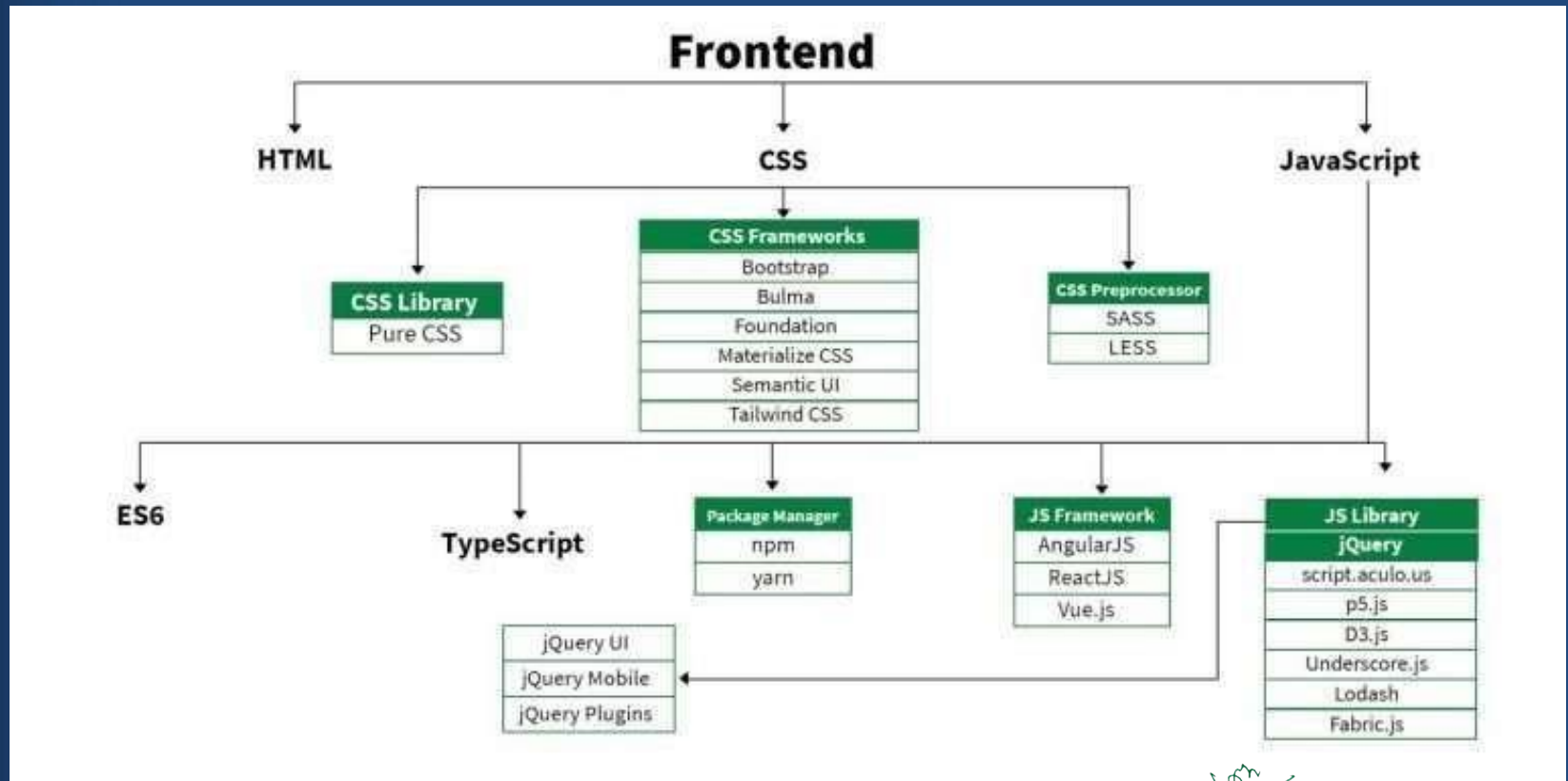



Frontend Roadmap

- **HTML:** HTML stands for HyperText Markup Language. It is used to design the front end portion of web pages using markup language. It acts as a skeleton for a website since it is used to make the structure of a website.
- **CSS:** Cascading Style Sheets fondly referred to as CSS is a simply designed language intended to simplify the process of making web pages presentable. It is used to style our website.
- **JavaScript:** JavaScript is a scripting language used to provide a dynamic behavior to our website.



Frontend Roadmap

- **Bootstrap:** Bootstrap is a free and open-source tool collection for creating responsive websites and web applications.

It is the most popular CSS framework for developing responsive, mobile-first websites. Nowadays, the websites are perfect for all the browsers (IE, Firefox, and Chrome) and for all sizes of screens (Desktop, Tablets, Phablets, and Phones).

- Bootstrap 4
- Bootstrap 5

Frontend Roadmap

Frontend Frameworks and Libraries:

- AngularJS
- React.js
- VueJS
- jQuery
- Bootstrap
- Material UI
- Tailwind CSS
- jQuery UI

Kannan
DIRECTOR
KOSHS INSTITUTE OF MANAGEMENT STUDIES
81/1, Kadusonnappanahalli,
Kannur Po, Hennur-Bagalur Road,
Bangalore-562 149

Backend Roadmap

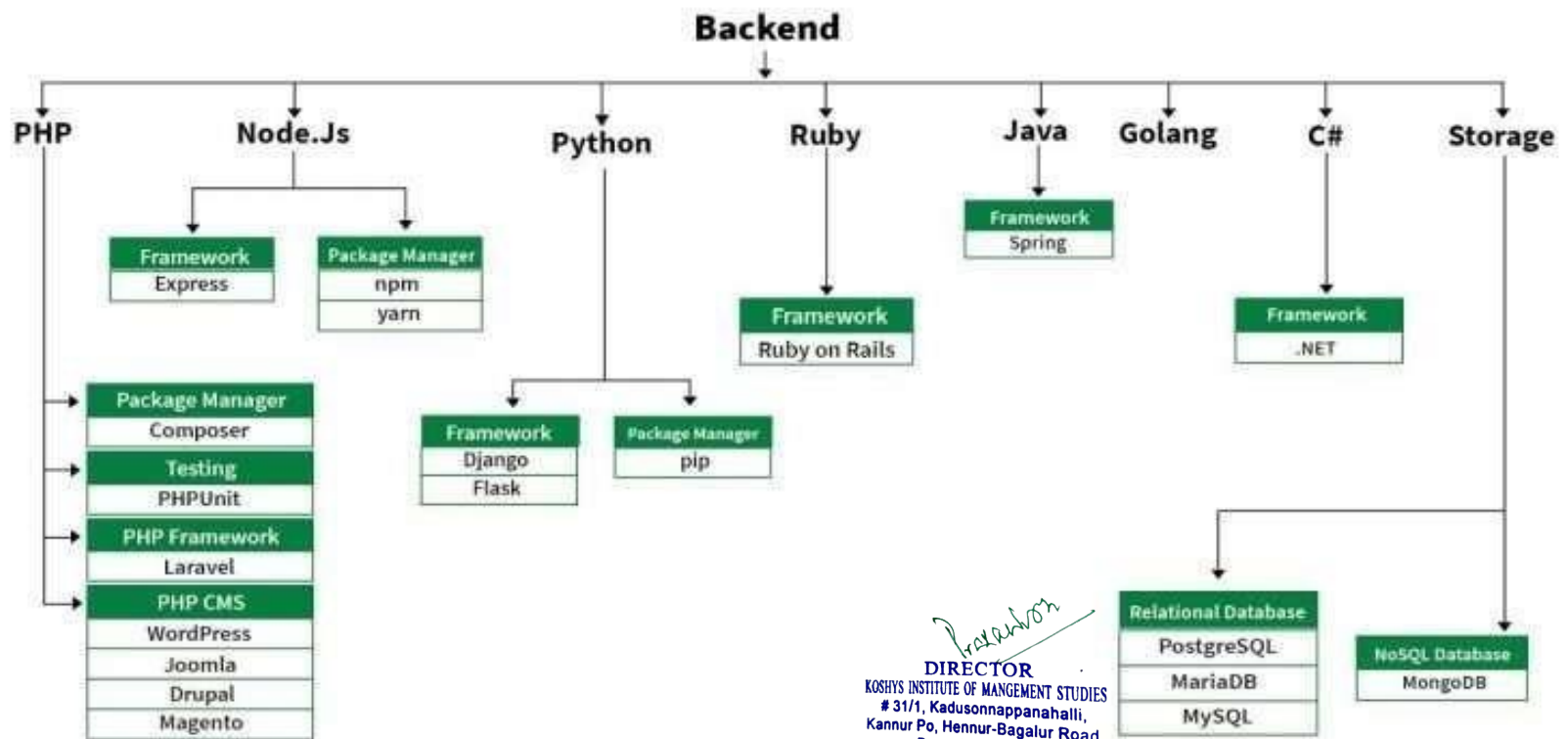



Backend Roadmap

- **PHP:** PHP is a server-side scripting language designed specifically for web development.
- **Java:** Java is one of the most popular and widely used programming language. It is highly scalable.
- **Python:** Python is a programming language that lets you work quickly and integrate systems more efficiently.
- **Node.js:** Node.js is an open source and cross- platform runtime environment for executing JavaScript code outside a browser.



Backend Roadmap

Back End Frameworks

The list of back end frameworks are:

Express,

Django,

Rails,

Laravel,

Spring, etc.

Full-Stack Developer

- A Full-Stack Developer is someone familiar with both front- and back-end development. They are generalists, adept at wearing both hats, and familiar with every layer of development. Obviously, employers want to hire Full-Stack Developers – according to an Indeed study, they are the fourth-most in-demand job in tech.
- If the title is contentious, it's in the generalist nature of the position. Developers who specialize in the front-end or back-end often bristle at the notion that someone could be equally adept at both – the expression “jack-of-all-trades, master of none” comes to mind.



What Does Web-Developer Do?

- Translating wireframe designs into working code
- Creating the architecture and content of a site
- Building in functionality and responsiveness
- Making a site go live
- Updating and renovating sites
- Troubleshooting, fixing bugs, and glitches

Tools Used

- WordPress
- Joomla!
- Drupal
- TYPO3
- Adobe Experience Manager
- Sketch – A toolkit for digital designs
- InVision Cloud – A leading digital product design platform
- Sublime Text – A code editor for advanced website design
- Foundation – A family of front-end frameworks
- Chrome DevTools – Tools from the popular browser that facilitate web development



Conclusion

- In today's Web development, a good page design is essential. A bad design will lead to the loss of visitors and that can lead to a loss of business. In general, a good page layout has to satisfy the basic elements of a good page design.
- This includes color contrast, text organization, font selection, style of a page, page size, graphics used, and consistency. In order to create a well-designed page for a specific audience.

References

- Google.com
- Wikipedia.org
- Studymafia.org
- Slidespanda.com

Prashant
DIRECTOR
KOSHS INSTITUTE OF MANAGEMENT STUDIES
81/1, Kadusonnappanahalli,
Kannur Po, Hennur-Bagalur Road,
Bangalore-562 149



KOSHYS

INSTITUTE OF MANAGEMENT STUDIES

NAAC Accredited & ISO 9001:2015 Certified

ATTENDANCE SHEET

SL.NO	STUDENT NAMES	SIGNATURE
1	Sreehariluv	
2	Abin	
3	Sidharth	
4	Saurav	
5	Sanjay	
6	Sayanth	
7	Aleena	
8	Amal	
9	Azomal	
10	Zahul	
11	Zanyith	
12	Soyda	
13	Anugrah	
14	Anandhu	
13	Akheil	
14	Tejus	
15	Sneha	
16	Atka	
17	Asika	
19	Krishnanjana	
10	Yadukrishna	
11	Andrew	
12	pranav	
13	Melvin	
14	Ajay	
15	Atthul	
16	Bairthwisay	
17	Alan Perushu	

DIRECTOR
KOSHYS INSTITUTE OF MANAGEMENT STUDIES
31/1, Kadusonnappanahalli,
Kannur Po, Hennur-Bagalur Road,
Bangalore-562 149

19	Bopi . p	Bopi
20	Nandana . kv	Nandana
21	Amal . p	Amal
22	Adhush	Adhush
23	Bandhya	Bandhya
24	Gokul	Gokul
25	Nayanthara . bija	Nayanthara
26	Abaganandha	Abaganandha
27	Aragha	Aragha
28	Amala	Amala
29	Ashwathy	Ashwathy
30	Aruna thi	Aruna
31	Vishnupriya	Vishnupriya
32	Ashwin	Ashwin
33	manzesh	manzesh
34	Sanal	Sanal
35	Sreelekshmi	Sreelekshmi
36	Jannath	Jannath
37	Suryyith	Suryyith
38	Leekshmi	Leekshmi
39	Navayug	Navayug
40	Kavies	Kavies
41	christiano	christiano
42	Akash	Akash
43	Jyoti	Jyoti
44	Jebin	Jebin
45	Vikram	Vikram
46	Vijay	Vijay
47	Vareen	Vareen



KOSHYS

INSTITUTE OF MANAGEMENT STUDIES

NAAC Accredited & ISO 9001 2015 Certified

DEPARTMENT OF BBA

Date: 20/10/2021

Circular

We are delighted to announce an upcoming Health and Hygiene Seminar focused on raising awareness about breast cancer. Kindly all the students and staffs are encouraged to participate in this significant event held on 26/10/2021 at 11 am in the auditorium.

Note: Participation is not compulsory

DIRECTOR
KOSHYS INSTITUTE OF MANGEMENT STUDIES
31/1, Kadusonnappanahalli,
Kannur Po, Hennur-Bagalur Road,
Bangalor-562 149

DIRECTOR



KOSHY'S

INSTITUTE OF MANAGEMENT STUDIES

NAAC Accredited & ISO 9001 2015 Certified

REPORT

“Breast Cancer Awareness” is spreading the awareness to the young girls and women about the importance of diagnosing cancer at early stages when treatment is easier and outcome is better. On 26th October 2021, on the theme “ETHNIC PINK OUT”-WALKATHON/ WORRIOR CHALLENGE which was hosted by Dr.Poivamma C U, Senior Consultant and Director- Breast Oncology and IMA Women’s Wing Yelahanka, Dr Pavan Kumar- IMA President, Yelahanka, Dr Renuka Devi, Chairman IMA- WDW, Dr Archana, Secretary IMA- WDW, Yelahanka, as part of the breast cancer awareness where our college were invited to attend the event and also participate. The students of KIMS attended the event and participated in the walkathon held at Allalassandra Lake, Main Gate, Yelahanka and also performed a flash mob.

The students were accompanied by the nursing supervisor of Cyte Care Hospital, Mrs Gilly. At the end of the program the students gained some knowledge about “BREAST CANCER AWARENESS”.

DIRECTOR
KOSHY'S INSTITUTE OF MANAGEMENT STUDIES
31/1, Kadusonnappanahalli,
Kannur Po, Hennur-Bagalur Road,
Bangalore-562 149



Pravankon
DIRECTOR
 KOSHYS INSTITUTE OF MANGEMENT STUDIES
 # 31/1, Kadusonnappanahalli,
 Kannur Po, Hennur-Bagalur Road,
 Bangalor-562 149

DIRECTOR



KOSHYS

INSTITUTE OF MANAGEMENT STUDIES

NAAC Accredited & ISO 9001 2015 Certified

ATTENDENCE SHEET

SL.NO	STUDENT NAMES	SIGNATURE
1)	Abin Bineeth	Abin
2)	Anwanth. P	Anwanth
3)	Hudairfa. Majeed	Hudairfa
4)	Alena	Alena
5)	Asjun	Asjun
6)	Abhishek	Abhishek
7)	Sangeeth	Sangeeth
8)	Ashish	Ashish
9)	Roshan	Roshan
10)	Joseph	Joseph
11)	Albin CR	Albin
12)	Benjo	Benjo
13)	Akshay	Akshay
14)	Vysakh	Vysakh
15)	Fawas	Fawas
16)	Jobyel	Jobyel
17)	Ashii	Ashii
18)	Sanjusha	Sanjusha
19)	Ashmitha	Ashmitha
20)	Ananthan menon	Ananthan menon
21)	Melvin	Melvin
22)	Cropi Ks	Cropi
23)	Suja	Suja
24)	Pariya	Pariya
25)	Jibin Simon	Jibin
26)	Thejas	Thejas
27)	Christo Davies	Christo
28)	Evan Ben George	Evan Ben

Prakashan
DIRECTOR
KOSHYS INSTITUTE OF MANAGEMENT STUDIES
31/1, Kadusonnappanahalli,
Kannur Po, Hennur-Bagalur Road,
Bangalore-562 149

29	Alsam	Asam
30	Athulya	Athulya
31	Akhil	Akhil
32	Paul	Paul
33	Vishu	Vishu
34	Fathima Nessim	Fathima
35	Midhun K	Midhun
36	Anax Joshy	AJ
37	Harsha	Harsha
38	Harli	Harli
39	Shehith KP	Shehith
40	Aiswarya	Aiswarya
41	Aravind	Aravind
42	Aswin	Aswin
43	Abiya	Abiya
44	Anrutha Skumar	Abiya
45	Fest'n	Fest'n
46	Temim	Temim
47	Goverdhan	Goverdhan
48	Sheffin	Sheffin
49	Saigorind	Saigorind
50	Sani	Sani
51	Amdal	Amdal
52	Prityon	Prityon
53	Ancy	Ancy

CERTIFICATE OF APPRECIATION

THIS ACKNOWLEDGES THAT

Kushmitha S

Has participated in the

**Health & Hygiene program focused on “Breast Cancer Awareness”
held on 26/10/2021 by the department of BBA**



Principal



DIRECTOR
KOSHY'S INSTITUTE OF MANAGEMENT STUDIES
31/1, Kedesomappaiahalli,
Kannur Dr, Banner-Sagar Road,
Bangalore-562 149

Director

CERTIFICATE OF APPRECIATION

THIS ACKNOWLEDGES THAT

Anushree K

Has participated in the

**Health & Hygiene program focused on “Breast Cancer Awareness”
held on 26/10/2021 by the department of BBA**



Principal



DIRECTOR
KOSHY'S INSTITUTE OF MANAGEMENT STUDIES
31/1, Kedesomappaiahalli,
Kannur Dr, Banner-Sagar Road,
Bangalore-562 149

Director

CERTIFICATE OF APPRECIATION

THIS ACKNOWLEDGES THAT

Anjitha S Ramesh

Has participated in the

**Health & Hygiene program focused on “Breast Cancer Awareness”
held on 26/10/2021 by the department of BBA**



Principal



DIRECTOR
KOSHY'S INSTITUTE OF MANAGEMENT STUDIES
31/1, Kedesomappaiahalli,
Kannur Dr. Kannur-Sagar Road,
Bangalore-562 149

Director

CERTIFICATE OF APPRECIATION

THIS ACKNOWLEDGES THAT

Merin Roy

Has participated in the

**Health & Hygiene program focused on “Breast Cancer Awareness”
held on 26/10/2021 by the department of BBA**



Principal



DIRECTOR
KOSHY'S INSTITUTE OF MANAGEMENT STUDIES
31/1, Kedesomappaiahalli,
Kannur Dr, Banner-Sagar Road,
Bangalore-562 149

Director

BLOOD DONATION CAMP

DATE:18/06/2021

VENUE: SEMINAR HALL

REPORT

List of objectives

- To educate the students on the beneficial aspects of voluntary blood and eye donation
- To raise awareness of the necessity of safe transfusion of blood and its components.
- To remove the myths and misconceptions associated with blood donation.
- To create awareness of the significance of eye donation and its usefulness to the visually impaired people.
- To encourage students to share their eyes after death.

List of outcomes

- The students will be able to understand their role in building a healthy society.
- The students will be informed of their social responsibility in this cause.
- The students will become aware of the importance of blood donation.
- The students will get to know the importance of a healthy environment.
- The students will have an important message of humanity.

The Department of BVA of Koshys Institute of Management Studies, Bangalore has organized Voluntary Blood donation camp in association with “Rotary Bangalore West R.I Dist.3190” and “SANKARA EYE HOSPITAL” on 18-01-2023. A total number of 220 NSS students’ volunteers have taken part in the event and made it a grand success.

The camp began at 9:00 am with a short inaugural function by Prof. Sandhya S, principal of Koshys institute of management studies and expressed her gratitude to the college for its continuous endeavour in this respect. She welcomed the medical team and motivated volunteers. She also congratulated pro. Kesavan, NSS coordinator and his team for successfully organizing the blood and eye importance of inculcating social responsibilities among students and encouraged them to donate blood. She further encouraged all the donors by saying “Gift of Blood is Gift of Life” and thanked all the donors for the noble steps they have taken and helped the fellow brethren.

On the day a team of doctors, nurses and were involved to collect blood from the donor. Before that screening tests were taken to identify the eligible donor for the blood donation.

Before camp, an orientation program was conducted regarding DO’s and DON’Ts during blood donation for all NSS volunteers of Koshys institute of management studies.

The Blood donation process of all the donors was being done by the medical team. The programme ended at 3.30 pm. All the teachers, students enthusiastically participated. Overall, 124 students donated their blood and 41 pledged their eyes.

A certificate of appreciation, donation card and refreshment were given to donors and volunteers as a token of gratitude.

DIRECTOR
KOSHYS INSTITUTE OF MANGEMENT STUDIES
31/1, Kadusonnappanahalli,
Kannur Po, Hennur-Bagalur Road,
Bangalor-562 149

Importance of volunteer blood donation

An adequate amount of blood is needed in health care facilities to meet the urgent need for patients facing trauma and other life saving procedures such as blood transfusions. Blood transfusion is an indispensable component of health care. It contributes saving million of lives every year in both routine and emergency situation. It further improves the life expectancy and quality of life of patients suffering from varied health conditions.



[A GLIMPSE ON BLOOD DONATION DAY]

Every year millions of lives are being saved because of blood donation. Blood donation has helped various patients who were suffering from life threatening conditions to live longer with higher quality of life. Blood is the gift of life. There is a wide gap between demand and access to safe blood. To maintain a safe and sustainable National blood components supply to all those in need, healthy donors must come forward for voluntary blood donation.

Observed on June 14 every year, world blood donor day is an initiative by the World Health Organization (WHO). WHO started this mission in 2004 to urge the government and national health authorities to provide enough resources and develop infrastructure for increasing

voluntary blood collection from donors. World Blood Donors Day is celebrated as the birthday of an Austrian Physician, Karl Landsteiner who discovered the first three human blood groups in the year 1901.

Prakashan
DIRECTOR
KOSHYS INSTITUTE OF MANGEMENT STUDIES
31/1, Kadusonnappanahalli,
Kannur Po, Hennur-Bagalur Road,
Bangalor-562 149

DIRECTOR

BLOOD DONATION CAMP

DATE:18/06/2021

VENUE: SEMINAR HALL

NUMBER OF DONORS:124

SL.NO	REGISTER NUMBER	STUDENT NAME
1	U19BU21M0121	MUHAMMED SAFWAN K V
2	U19BU21M0211	PRIYAMOL P S
3	U19BU21M0193	AMAN P DEV
4	U19BU21M0195	MIJAS S
5	U19BU21M0085	MONCY VARUGHESE
6	U19BU21S0004	ABIN BINEESH
7	U19BU21S0183	ANANTHAKRISHNA V NAIR
8	U19BU21S0066	AJAY T
9	U19BU21S0180	ASWAJ RAMACHANDRAN K
10	U19BU21S0182	ANWAY V
11	U19BU21S0020	ALAN PAUL
12	U19BU21S0027	ANIRUDH K BABU
13	U19BU21S0025	ANANTHAKRISHNAN A
14	U19BU21C0096	VIPIN M V
15	U19BU21C0090	PRANAVE KP
16	U19BU21C0122	VAISHNAV S
17	U19BU21C0110	ADARSH
18	U19BU21C0055	ABHIRAM KOZHUMMAL
19	U19BU21C0119	MUHAMMED SHIBIRI C
20	U19BU21C0079	MOHAMMED AKHEEL
21	U19BU21C0093	SHAMIL V

22	U19BU21C0086	MUHAMMED SHUAIB CN
23	U19BU21C0121	MOHAMMED NOUSHIN K
24	U19BU21C0063	APARNA SABU
25	U19BU21C0059	ALEENA JIJI

26	U19BU21C0060	ALEX JOSEPH
27	U19BU21C0056	ABHIRAM SUDHEER
28	U19BU21C0116	K JAVAD
29	U19BU21C0101	AKASH C VARGHESE
30	U19BU21M0043	ALFIYA D
31	U19BU21M0208	PARVATHY P S
32	U19BU21M0171	DANDE MAHESH
33	U19BU21M0293	JOMON SHAJI
34	U19BU21M0265	ANSHIKA AJITH
35	U19BU21M0002	ABU RAIZAAL
36	U19BU21M0015	ANU S
37	U19BU21M0095	VAIKUNDA PRABHU J
38	U19BU21M0279	ANANDHU K SAIJU
39	U19BU21M0189	SHAMIL CHERATTIYADAN
40	U19BU21M0133	VIGNESH V K
41	U19BU21M0198	JACKS N G
42	U19BU21M0334	MOHAMMAD FIDHAN
43	U19BU21M0046	APARNA SURESH
44	U19BU21M0233	ADITHYA M
45	U19BU21M0283	AMRUTHA K
46	U19BU21M0280	ABIYA MARY BIJU
47	U19BU21M0290	AROMAL P
48	U19BU21M0055	ABUTHALIB T M
49	U19BU21M0315	MUHEENUDHEEN MIDLAJ M C
50	U19BU21M0333	K T MUHAMMAD SINAN
51	U19BU21S0227	VEERAPURAM NAGENDRA CHARY
52	U19BU21S0193	VISHNU PRABHAKARAN U
53	U19BU21S0194	SREEPCHAND MK
54	U19BU21S0237	REMORN SHAJI
55	U19BU21S0220	RAHIL ABDUL KADER
56	U19BU21S0109	SUSHMA M

57	U19BU21S0224	SUMIYA. S
58	U19BU21S0140	SNEHITH KP
59	U19BU21S0163	SAYANA. P
60	U19BU21S0192	SHAABAS AHAMMED
61	U19BU21S0196	SIDHARTH TV
62	U19BU21S0179	VRINDHA RAVI
63	U19BU21S0104	SIDRA KHATOON
64	U19BU21S0222	SHAHLA
65	U19BU21S0105	SNEHA V
66	U19BU21S0189	VISHNU ASHOKAN
67	U19BU21S0154	RITHUVARNA P
68	U19BU21S0221	SINAN SABITH
69	U19BU21S0165	SAMEER S IBRAHIM
70	U19BU21S0229	SHIBIN K
71	U19BU21S0210	SREYAMOL SAJU
72	U19BU21S0175	JITHIN JOY
73	U19BU21S0161	JUSTIN OOMMEN
74	U19BU21S0178	BINISH KUMAR
75	U19BU21S0050	GODWIN BIJU K
76	U19BU21S0053	GOUTHAM
77	U19BU21S0040	BENSON THOMAS
78	U19BU21S0063	BISR KP
79	U19BU21S0174	JYOTHIS JOGESH
80	U19BU21S0159	DELVIN DEVASSY
81	U19BU21S0236	ATHUL TA
82	U19BU21S0042	CHAITHANYA
83	U19BU21S0034	ASWIN MB
84	U19BU21S0003	ABHISHEK VARGHESE
85	U19BU21S0149	AJIN ROBERTSON
86	U19BU21S0013	AKSHAY DINESH
87	U19BU21S0028	ANOOSH S
88	U19BU21S0022	ALPHIN ANTONY SANTHOSH
89	U19BU21S0010	AJAY CHANDRAN J
90	U19BU21S0023	ALWIN KEVIN
91	U19BU21S0061	APOORVA Y S
92	U19BU21S0148	AMALJITH MP
93	U19BU21S0006	ADHITHYAN .S

94	U19BU21S0152	ARBEEN KOUSAR
95	U19BU21S0024	ANAGHA VIJAYAN GP
96	U19BU21S0181	ANAND CS
97	U19BU21S0017	ALAN BIJI
98	U19BU21S0012	AJAY SUNIL
99	U19BU21S0029	ARAVIND EN
100	U19BU21S0015	AKSSA
101	U19BU21S0002	ABHINAV SUNIL
102	U19BU21S0162	AINCHEL SHIBU
103	U19BU21S0005	ABIN VR
104	U19BU21S0225	AKASH BIJU
105	U19BU21S0032	ASHWINKUMAR A
106	U19BU21S0021	ALAN RAJ C
107	U19BU21S0233	AMARJITH MS
108	U19BU21S0200	ANKIT PRADEEP
109	U19BU21S0016	ALAIN SUNIL
110	U19BU21S0033	ASWAJITH K
111	U19BU21S0026	ANCY ANTOO
112	U19BU21S0184	AKASH SHIBU
113	U19BU21S0145	AKSHAY Y
114	U19BU21S0009	AJAS MUHAMMED B
115	U19BU21S0031	ASHISH A
116	U19BU21S0019	ALAN K DIPIN
117	U19BU21S0219	ASMITHA C R
118	U19BU21S0188	ABHIJITH KRISHNA AV
119	U19BU21S0185	ADWAIDH RATNAKARAN
120	U19BU21S0011	AJAY EM
121	U19BU21S0030	ASHA G
122	U19BU21S0007	ADIDEV A
123	U19BU21S0209	ASWANATH P
124	U19BU21S0034	ASWIN MB

DIRECTOR
 KOSHYS INSTITUTE OF MANGEMENT STUDIES
 # 31/1, Kadusonnappanahalli,
 Kannur Po, Hennur-Bagalur Road,
 Bangalor-562 149
DIRECTOR

5.1.2

LIFE SKILLS

[YOGA, HEALTH & HYGIENE AND ICT]

[Supporting Documents]

FOR

ACADEMIC YEAR 2019-2020



KOSHYS

INSTITUTE OF MANAGEMENT STUDIES

NAAC Accredited & ISO 9001 2015 Certified

DEPARTMENT OF BBA

Date: 14/06/2019

Circular

As part of our commitment to promoting holistic well-being and fostering a healthy lifestyle, we are delighted to announce the celebration of International Yoga Day on June 21, 2019 at 9 AM to 11.30 AM in the auditorium. This event aims to create awareness about the numerous benefits of yoga and provide an opportunity for our college community to embrace this ancient practice. All are invited to this event.

Prasanna
DIRECTOR
KOSHYS INSTITUTE OF MANAGEMENT STUDIES
31/1, Kadusonnappanahalli,
Kannur Po, Hennur-Bagalur Road,
Bangalore-562 149

DIRECTOR



KOSHYS

INSTITUTE OF MANAGEMENT STUDIES

NAAC Accredited & ISO 9001 2015 Certified

Report on International Yoga Day celebration

Organized By

KOSHYS GROUP OF INSTITUTIONS

[On 21-06-2019, Friday 09:00AM to 11:30 AM]

International Yoga Day was celebrated as on 21st June 2019 in the Auditorium at 9 am by the Koshys group of institutions under the guidance of Rachana, Assistant Professor, KIMS.

The International Yoga Day celebration has sown seeds of transformation within our college community. Like the postures that stretch and strengthen, may the impact of this event stretch beyond today, strengthening our resolve to embrace healthier lifestyles. As we disperse from this shared space of mindfulness, let the seeds planted today blossom into a garden of well-being that flourishes throughout the academic year.

As the yoga mats are rolled up and the echoes of collective breaths subside, let us take a moment to reflect on the profound experience of International Yoga Day at Koshys Group Of Institution. The fusion of mind, body, and spirit was palpable, and it is our hope that the serenity cultivated today will resonate in the days to come. May the awareness raised and the bonds forged during this celebration continue to inspire a journey of self-discovery and well-being.

As we reflect on this celebration, it is evident that the International Yoga Day event at Koshys Group Of Institution played a pivotal role in promoting physical, mental, and spiritual well-being, fostering a sense of community, and encouraging a commitment to a healthier and balanced life.

DIRECTOR
KOSHYS INSTITUTE OF MANGEMENT STUDIES
31/1, Kadusonnappanahalli,
Kannur Po, Hennur-Bagalur Road,
Bangalore-562 149



“Resource person: Rachana 26/06/2019”

Rachana
DIRECTOR
KOSHYS INSTITUTE OF MANGEMENT STUDIES
31/1, Kadusonnappanahalli,
Kannur Po, Hennur-Bagalur Road,
Bangalor-562 149

DIRECTOR



KOSHY'S

INSTITUTE OF MANAGEMENT STUDIES

NAAC Accredited & ISO 9001 2015 Certified

ATTENDANCE SHEET

SL.NO	STUDENT NAMES	SIGNATURE
01	Athifa parveez	Athifa.
02	Shifa	Shifa
03	Chandan	Chandan
04	Varun	Varun
05	Arun	Arun
06	Ankitha	Ankitha
07	Sneha.v	Sneha.v
08	Rohith	Rohith
09	Vamsi	Vamsi
10	Zaiba Ameen.	Zaiba
11	Sumiya.s	Sumiya.s
12.	Soniya	Soniya
13	Aishwarya	Aishwarya
14	Harshitha.	Harshitha.
15	Sidra	Sidra
16	Malathi	Malathi
17	Shree Vidhya	Shree Vidhya
18	Sarhosa.M	Sarhosa.M
19.	Ranjith	Ranjith
20	Neha	Neha
21	Mohammed Fuzail	Fuzail
22	Sadig.s	Sadig.s
23	Sruasti	Sruasti
24.	Alia	Alia
25	Shradha	Shradha
26	Karthik	Karthik
27.	Sunya	Sunya
28.	Hitesh	Hitesh

Prakash

DIRECTOR
KOSHY'S INSTITUTE OF MANAGEMENT STUDIES
31/1, Kadusonnappanahalli,
Kannur Po, Hennur-Bagalur Road,
Bangalore-562 149

29.	Shamass	<u>Sud</u>
30	Mohammed Imran.	<u>Imran.</u>
31	Zoya	<u>Zoya.</u>
32	Deeksha	<u>Deek</u>
33	Zaara.	<u>Zaara</u>
34	Veeri	<u>Ve</u>
35	Isha	<u>Ish</u>
36	Munawar	<u>Mu</u>
37	Zakir	<u>Zakir</u>
38	Sangeeta	<u>Sang</u>
39	Abhishek	<u>Abhi</u>
40	Vicky	<u>Vicky</u>
41	Vinay	<u>Vin</u>
42	Uagana	<u>Uag</u>
43	Chandana.	<u>Chan</u>
44.	Alwin	<u>Alwin</u>
45	Shanisha	<u>Shan</u>
46	Shahed	<u>Shah</u>
47.	Sarvan	<u>Sarvan</u>
48.	Neeraj	<u>Neeraj</u>
49.	Kareena	<u>Kare</u>
50	Raghav	<u>Ragha</u>
51	Raha Kapoor	<u>Raha</u>
52	Afreen	<u>Afreen</u>
53	Saniya Khanom	<u>Saniya</u>
54	Farheen	<u>Farheen</u>
55	Mohammed Uvez	<u>Uvez</u>
56	Asma	<u>Asma</u>

Prakashan
DIRECTOR
KOSHY'S INSTITUTE OF MANAGEMENT STUDIES
31/1, Kadusonnappanahalli,
Kannur Po, Hennur-Bagalur Road,
Bangalore-562 149

DIRECTOR



CERTIFICATE OF PARTICIPATION

THIS ACKNOWLEDGES THAT

Reshmi Suresh

Has participated in the

“International Yoga Day” held on 21/06/2019 by the department of BBA

A handwritten signature in blue ink, appearing to read "S. Suresh", is positioned above the Principal's name.

Principal

A handwritten signature in blue ink, appearing to read "S. Suresh", is positioned above the Director's name.

DIRECTOR
KOSHYS INSTITUTE OF MANAGEMENT STUDIES
31/1, Kadusonnappanahalli
Kannur Po, Hebbur, Bengaluru
Bangalore - 560 049

Director



CERTIFICATE OF PARTICIPATION

THIS ACKNOWLEDGES THAT

Abhiram A

Has participated in the

“International Yoga Day” held on 21/06/2019 by the department of BBA

A handwritten signature in blue ink, appearing to read "Sheplee", is written over a horizontal line.

Principal

A handwritten signature in blue ink, appearing to read "Dell", is written over a horizontal line.

DIRECTOR
KOSHYS INSTITUTE OF MANAGEMENT STUDIES
31/1, Kadusonnappanahalli
Kannur Po, Hebbur, Bengaluru North
Bangalore - 560049

Director



CERTIFICATE OF PARTICIPATION

THIS ACKNOWLEDGES THAT

Ujwel Krishna M

Has participated in the

“International Yoga Day” held on 21/06/2019 by the department of BBA

A handwritten signature in blue ink, appearing to read "Ujwel Krishna M", is written over a horizontal line.

Principal

A handwritten signature in blue ink, appearing to read "Ujwel Krishna M", is written over a horizontal line.

DIRECTOR
KOSHYS INSTITUTE OF MANAGEMENT STUDIES
31/1, Kadusonnappannahalli
Kannur Po, Hebbur, Bengaluru
Bangalore - 560049

Director



CERTIFICATE OF PARTICIPATION

THIS ACKNOWLEDGES THAT

M Shibil

Has participated in the

“International Yoga Day” held on 21/06/2019 by the department of BBA

A handwritten signature in blue ink, appearing to read "Shree...", is positioned above the Principal's name.

Principal

A handwritten signature in blue ink, appearing to read "S...", is positioned above the Director's name and address.

DIRECTOR
KOSHYS INSTITUTE OF MANAGEMENT STUDIES
31/1, Kadusonnappanahalli
Kannur Po, Hebbur, Bengaluru
Bangalore - 560 049

Director



CERTIFICATE OF PARTICIPATION

THIS ACKNOWLEDGES THAT

Joyal Merin Shaji

Has participated in the

“International Yoga Day” held on 21/06/2019 by the department of BBA

A handwritten signature in blue ink, appearing to read "Deepveer", is positioned above the Principal's name.

Principal

A handwritten signature in blue ink is positioned above the Director's name.

DIRECTOR
KOSHYS INSTITUTE OF MANAGEMENT STUDIES
31/1, Kadusonappanahalli
Kannur Po, Hebbur, Bagalur Taluk
Bangalore - 560 049

Director



KOSHYS

INSTITUTE OF MANAGEMENT STUDIES

NAAC Accredited & ISO 9001 2015 Certified

DEPARTMENT OF BCA

Date: 14/03/2019

Circular

This is to inform that **Department of BCA** is conducting two-days boot camp workshop for “**Backend Web Development**” for second year BCA students on 20th March, 2019 in the seminar hall. Participation is compulsory for everyone.

DIRECTOR
KOSHYS INSTITUTE OF MANGEMENT STUDIES
31/1, Kadusonnappanahalli,
Kannur Po, Hennur-Bagalur Road,
Bangalor-562 149

DIRECTOR



KOSHYS

INSTITUTE OF MANAGEMENT STUDIES

NAAC Accredited & ISO 9001 2015 Certified

REPORT

The department BCA organised Two-Days Backend Web Development Boot Camp workshop on 20th march 2019.

Workshop provided participants with an intense and immersive learning experience and this was possible by **Birendar Sharma** from Infotech Limited Technologies. The combination of theoretical knowledge, practical exercises, and exposure to industry best practices contributed to a well-rounded and impactful workshop.

Feedback from participants was positive overall. Attendees expressed satisfaction with the hands-on nature of the workshop, the relevance of the topics covered, and the opportunity to work on a practical project. Many participants felt more confident in their ability to contribute to backend development projects.

Participants had the opportunity to work on a guided project, integrating the concepts learned throughout the workshop. This practical project development allowed them to apply their skills in a cohesive manner and experience the end-to-end process of building a backend system.

The workshop heavily emphasized hands-on learning through labs and practical exercises. Participants engaged in coding challenges, project-based activities, and interactive exercises to apply theoretical concepts and develop practical skills.

DIRECTOR
KOSHYS INSTITUTE OF MANAGEMENT STUDIES
31/1, Kadusonnappanahalli,
Kannur Po, Hennur-Bagalur Road,
Bangalore-562 149

DIRECTOR



Top Backend Programming Languages



Prakashan
DIRECTOR
KOSHYS INSTITUTE OF MANGEMENT STUDIES
31/1, Kadusonnappanahalli,
Kannur Po, Hennur-Bagalur Road,
Bangalor-562 149

DIRECTOR

CERTIFICATE

OF PARTICIPATION

This is to Certify That

AVINASH N

This is a certify that Avinash has participated in the Two day Boot Camp Workshop on Backend Web Development held at koshy's Institute of management studies from 20th to 21th March 2019

Prof. Sandhya S
Principal

Dr. Prakash B Nayak
Director

DIRECTOR
KOSHYS INSTITUTE OF MANGEMENT STUDIES
31/1, Kadusonnappanahalli,
Kannur Po, Hennur-Bagalur Road,
Bangalore-562 149

CERTIFICATE

OF PARTICIPATION

This is to Certify That

ESHWAR

This is a certify that Eshwar has participated in the Two day Boot Camp Workshop on Backend Web Development held at koshy's Institute of management studies from 20th to 21th March 2019



Prof. Sandhya S
Princip al



Dr. Prakash B Nayak
Director



DIRECTOR
KOSHYS INSTITUTE OF MANGEMENT STUDIES
31/1, Kadusonnappanahalli,
Kannur Po, Hennur-Bagalur Road,
Bangalor-562 149

JAVA BACKEND DEVELOPMENT COURSE

MODULE - 1 INTRODUCTION TO JAVA & BACKEND DEVELOPMENT

- What is back end development and it's benefits?
- MEAN vs MERN vs Java FSD stack ● What are back-end frameworks?
- Back end development applications and use cases
- Overview of Web Development Tools
- Introduction to VS Code Why version Control?
- Introduction to Git Github Basics,
- Branches Flows Introduction to Postman API sharing using Postman
- Core Java Programming
- Basic Programming using Java
- Flow charts in Java
- Variables
- Data types
- Conditionals
- Loops
- Operators
- Functions
- Arrays
- Strings & 2D Arrays
- OOPS in Java
- Packages and Multi-Threading
- Packages and Interfaces
- Access Specifiers: Public, Private, Protected and
- Package
- Exception Handling: Try, Catch, Finally, Throw and
- Throws
- Multi-Threading: Runnable Interface, Extending a ● Thread Class, Synchronization in Threads

MODULE - 2 CORE JAVA PROGRAMMING

- Java Collections
- Wrapper Classes and Inner Classes: Integer,
- Character, Boolean, Float etc
- Applet Programs: How to write GUI programs with Applet, Java.lang, Java.io, Java.util
- Collections: ArrayList, Vector, HashSet, TreeSet,
- HashMap, HashTable
- XML & JDBC
- Introduction to XML
- Writing XML files
- DOM Parser – Writing into an XML file and Parsing an XML file
- SAX Parser, XSL
- Introduction to SQL: Connect, Insert, Update, Delete, Select
- Introduction to JDBC and Architecture of JDBC
- Types of Drivers: Type 1/2/3/4 drivers
- Insert/Update/Delete/Select Operations using
- JDBC
- Batch Processing Transaction
- Management: Commit and Rollback

MODULE - 3 JPA & HIBERNATE

- Introduction to Hibernate
- Architecture of Hibernate
- Database Operations: Insert/Update/Delete/Select
- Inheritance
- Collections
- HQL and Restrictions
- Caching in Hibernate
- JPA for object, relational mapping
- First and Second Level of caching
- Querying Database using JPL

MODULE - 4 APACHE MAVEN

- Maven Fundamentals
- Software Setup - Command Line and Eclipse
- Pom.xml and Directory Structure
- Multi-Module Project Creation
- Scopes
- Dependency Management
- Profiles

MODULE - 5 SPRING FRAMEWORK

- Architecture
- Display a Sample Message
- IoC Containers
- Bean Definition
- Bean Scopes
- Bean Post Processors
- Aspect Oriented Programming (AOP Integrating Spring framework with
- Hibernate
- Transaction Management
- Ajax Framework and Design Patterns: DAO, DTO, MVC
- Intercepting filters
- Front Controller
- Business Delegate
- Spring AOP
- Developing Spring Rest API
- Spring Boot for Rapid Development
- Spring Web Flux

MODULE - 6 DATABASES

- Introduction to Databases
- SQL Basics
- SQL Joins

- Displaying Data from multiple tables
- Subqueries & Nested Queries
- Grouping Data and Computing Aggregate
- MongoDB Basics
- CRUD Operations
- Schemas, Projections
- Database Normalization

Prakash
DIRECTOR
KOSHYS INSTITUTE OF MANGEMENT STUDIES
31/1, Kadusonnappanahalli,
Kannur Po, Hennur-Bagalur Road,
Bangalor-562 149



KOSHYS

NAAC Accredited & ISO 9001:2015 Certified

ATTENDANCE SHEET

SL.NO	STUDENT NAMES	SIGNATURE
1	Aswin MB	
2	Ishad V	
3	Sreehari K V	
4	Coakul Krishna	
5	Adwait Ratnakaran	
6	Aswin Krishna	
7	Ajay Chandran	
8	Aravind Ashok	
9	Arthul Krishna	
10	Rigin Rosh	
11	Adith Anand	
12	Ajmal zain	
13	Arthul Damodaran	
14	Neeraj P Raj	
15	Mano maharaj	
17	Shravan K P	
18	Jinshad P	
19	Jithin K V	
20	Hisham V P	
21	Arijun Dev	
22	Vishnu Prasad	
23	Subin MS	
24	Sandra V S	
25	Nandana Prakash	
26	Anamika Rajan	
27	Alveena Jaison	
28	Sreelakshmi	
29	Blessy Radhose	

Praveen
DIRECTOR
KOSHYS INSTITUTE OF MANAGEMENT STUDIES
31/1, Kadusonnappanahalli,
Kannur Po, Hennur-Bagalur Road,
Bangalore-562 149

30	Shivani Lakshmi	Shivani
31	Lakshmi Anns	Lakshmi
32	Devika	Devika
33	Anu Mol	Anu Mol
34	Merly Doss Joy	Merly Doss Joy
35	Alphin Anthony	Alphin Anthony
36	Anandh Raj	Anandh Raj
37	Ammudhan K	Ammudhan
38	Karthik Surya	Karthik Surya
39	Lena Mathew	Lena Mathew
40	Ancy	Ancy
41	Remini	Remini
42	Deepa K R	Deepa K R
43	Krishnendu	Krishnendu
44	Anagha K V	Anagha K V
45	Ragendhu K P	Ragendhu K P
46	Adithyan S	Adithyan S
46	Adithyan S manoj	Adithyan S manoj
47	Abin Varghese	Abin Varghese
48	Karthik K	Karthik K
49	AFis Anas	AFis Anas
50	Emerson Jerson Femandes	Emerson Jerson Femandes
51	Pranav Prakash	Pranav Prakash
52	Shefin Michael	Shefin Michael
53	Abhijith P	Abhijith P
54	Rithul Raj	Rithul Raj
55	Jahan Moris	Jahan Moris
56	Balan J	Balan J
57	K P Umman	K P Umman
58	Kenath Sebastian	Kenath Sebastian
59	Abu bakkar Siddique	Abu bakkar Siddique
60	Amal Joseph	Amal Joseph
61	Mohammad Al Irfan	Mohammad Al Irfan



KOSHYS

INSTITUTE OF MANAGEMENT STUDIES

NAAC Accredited & ISO 9001 2015 Certified

DEPARTMENT OF BCA

Date:29/11/2019

Circular

In line with our commitment to community welfare and education, we are conducting a talk on raising awareness about Aids on 01/12/2019 at 11am in the auditorium. All the students and staffs are requested to take part in the event.

DIRECTOR
KOSHYS INSTITUTE OF MANGEMENT STUDIES
31/1, Kadusonnappanahalli,
Kannur Po, Hennur-Bagalur Road,
Bangalor-562 149

DIRECTOR



KOSHYS

INSTITUTE OF MANAGEMENT STUDIES

NAAC Accredited & ISO 9001 2015 Certified

 **KOSHYS**
INSTITUTE OF HEALTH SCIENCES



1ST DECEMBER

world
AIDS
day

"LET COMMUNITIES
LEAD"



Prasanna
DIRECTOR
KOSHYS INSTITUTE OF MANAGEMENT STUDIES
31/1, Kadusonnappanahalli,
Kannur Po, Hennur-Bagalur Road,
Bangalore-562 149

**Report of Aids Day Awareness Programme Titled
“United against HIV, together for health”**

Date:1st December 2019

Department: BCA

Venue: Auditorium

The World AIDS day on 1st December began with an enthusiastic assembly of students from 1st and 2nd semester BCA, willingly looking forward to creating awareness among the people on the AIDS day and its significance.

The bag of events for the day was inaugurated by Dr. Biji Joseph with a wave of white flag that marked the first event which was the rally, which strongly yet peacefully focused on attracting the people's attention on the slogan for the Day that was “United against HIV, together for health”. The rally was led to the PHC of _ where it was addressed by Mrs.Hemlata Health officer and other health care members. As the day progressed students from The Village Govt. School were brought to the PHC.A flash

mob in order to comfort the students were organized by the NSS members of KOSHYS INSTITUTE OF MANAGEMENT STUDIES Furthermore, they were given a brief health talk on AIDS, it's cause, and its prevention.

DIRECTOR
KOSHYS INSTITUTE OF MANGEMENT STUDIES
31/1, Kadusonnappanahalli,
Kannur Po, Hennur-Bagalur Road,
Bangalor-562 149

DIRECTOR



KOSHY'S

INSTITUTE OF MANAGEMENT STUDIES

NAAC Accredited & ISO 9001 2015 Certified

ATTENDENCE SHEET

SL.NO	STUDENT NAMES	SIGNATURE
01	Athifa parveez	Athifa.
02	Shifa	Shifa
03	Chandan	Chandan
04	Varun	Varun
05	Arun	Arun...
06	Ankitha	Ankitha
07	Sneha.V	Sneha.V
08	Rohith	Rohith
09	Vamsi	Vamsi
10	Zaiba Aheen.	Zaiba
11	Sumiya.S	Sumiya.S
12	Soniya	Soniya
13	Aishwarya	Aishwarya
14	Harshitha.	Harshitha.
15	Sidra	Sidra
16	Malathi	Malathi
17	Shree Vidhya	Shree Vidhya
18	Sarhama.M	Sarhama.M
19	Ranjith	Ranjith
20	Neha	Neha
21	Mohammed Fuzail	Fuzail
22	Sadig.S	Sadig.S
23	Srusti	Srusti
24	Alia	Alia
25	Shradha	Shradha
26	Karthik	Karthik
27	Susya	Susya
28	Hitesh	Hitesh

Pravaran

DIRECTOR
KOSHY'S INSTITUTE OF MANAGEMENT STUDIES
31/1, Kadusonnappanahalli,
Kannur Po, Hennur-Bagalur Road,
Bangalore-562 149

29.	Shamass	<u>Sul</u>
30	Mohammed Imran.	<u>Imran.</u>
31	Zoya	<u>Zoya.</u>
32	Deeksha	<u>Deek</u>
33	Zaara.	<u>Zaara</u>
34	Veeri	<u>Ve</u>
35	Isha	<u>Ish</u>
36.	Munawar	<u>Mu</u>
37	Zakir	<u>Zakir</u>
38	Sangeeta	<u>Sang</u>
39.	Abhishek	<u>Abhi</u>
40	Vicky	<u>Vickay</u>
41	Vinay	<u>Vin</u>
42	Gagana	<u>Gan</u>
43	Chandana.	<u>Chan</u>
44.	Alwin.	<u>Alwin</u>
45	Shanisha	<u>Shan</u>
46	Shahed	<u>Shan</u>
47.	Sarvan	<u>Sarvan</u>
48.	Neeraj	<u>Neeraj</u>
49.	Kareena	<u>Kare</u>
50	Raghu	<u>Raghu</u>
51	Raha Kapoor	<u>Raha</u>
52	Afreen	<u>Afreen</u>
53	Saniya Khanum	<u>Saniya</u>
54	Fasheen	<u>Fasheen</u>
55	Mohammed Uvez	<u>Uvez</u>
56	Asma	<u>Asma</u>

CERTIFICATE OF APPRECIATION

THIS ACKNOWLEDGES THAT

Joyal Merin Shaji

Has participated in the

**Health & Hygiene program focused on “Aids Day Awareness” held on
01/12/2019 by the department of BCA**



Principal



DIRECTOR
KOSHY'S INSTITUTE OF MANAGEMENT STUDIES
31/1, Kadusonnappanahalli
Kannur Po, Healur Bagalur Road
Bangalore - 560 149

Director

CERTIFICATE OF APPRECIATION

THIS ACKNOWLEDGES THAT

M Shibil

Has participated in the

**Health & Hygiene program focused on “Aids Day Awareness” held on
01/12/2019 by the department of BCA**



Principal



DIRECTOR
KOSHY'S INSTITUTE OF MANAGEMENT STUDIES
31/1, Kadusonnappanahalli
Kannur Po, Healur Bagalur Road
Bangalore - 560 149

Director

CERTIFICATE OF APPRECIATION

THIS ACKNOWLEDGES THAT

Reshmi Suresh

Has participated in the

**Health & Hygiene program focused on “Aids Day Awareness” held on
01/12/2019 by the department of BCA**



Principal



DIRECTOR
KOSHY'S INSTITUTE OF MANAGEMENT STUDIES
31/1, Kadusonnappanahalli
Kannur Po, Hebbur Bagalur Road
Bangalore - 560 149

Director

CERTIFICATE OF APPRECIATION

THIS ACKNOWLEDGES THAT

Ujwel Krishna M

Has participated in the

**Health & Hygiene program focused on “Aids Day Awareness” held on
01/12/2019 by the department of BCA**



Principal



DIRECTOR
KOSHY'S INSTITUTE OF MANAGEMENT STUDIES
31/1, Kadusonnappanahalli
Kannur Po, Hebbur Bagalur Road
Bangalore - 560 149

Director



KOSHYS™

INSTITUTE OF MANAGEMENT STUDIES

AFFILIATED TO BENGALURU NORTH UNIVERSITY

CERTIFICATE OF APPRECIATION

THIS ACKNOWLEDGES THAT

Abiram A

Has participated in the

**Health & Hygiene program focused on “Aids Day Awareness” held on
01/12/2019 by the department of BCA**

DIRECTOR
KOSHYS INSTITUTE OF MANAGEMENT STUDIES
31/1, Kadusonnappanahalli,
Kannur Po, Hennur-Bagalur Road,
Bangalore-562 149



KOSHYS
INSTITUTE OF MANAGEMENT STUDIES

NAAC Accredited & ISO 9001 2015 Certified

DEPARTMENT OF BBA

Venue: Auditorium

Date:29/11/2019

Circular

As part of our dedication to community well-being and education, we are hosting a presentation aimed at increasing awareness about AIDS. This event will take place on December 1st, 2019, at 11am in the auditorium. We invite all students and staff to join us for this informative session, if they wish to participate.

DIRECTOR
KOSHYS INSTITUTE OF MANAGEMENT STUDIES
31/1, Kadusonnappanahalli,
Kannur Po, Hennur-Bagalur Road,
Bangalore-562 149

DIRECTOR



KOSHY'S

INSTITUTE OF MANAGEMENT STUDIES

NAAC Accredited & ISO 9001 2015 Certified

Report on the AIDS Awareness Program Entitled "United Against HIV, Together for Health"

REPORT

Date: December 1st, 2019

Department: Bachelor of Computer Applications (BBA)

Venue: Auditorium

The observance of World AIDS Day on December 1st commenced with an eager gathering of BCA students from the 1st and 2nd semesters, demonstrating their willingness to raise awareness about AIDS and its significance.

Dr. Biji Joseph inaugurated the day's activities by hoisting a white flag, signaling the commencement of the first event, a rally. This rally aimed to peacefully draw attention to the day's theme, "United against HIV, together for health." The procession proceeded to the Primary Health Center (PHC), where Mrs. Hemlata, the Health Officer, and other healthcare professionals addressed the participants. Later in the day, students from The Village Government School also joined the event at the PHC.

DIRECTOR
KOSHY'S INSTITUTE OF MANAGEMENT STUDIES
31/1, Kadusonnappanahalli,
Kannur Po, Hennur-Bagalur Road,
Bangalore-562 149



“Resource person: dr. Bijji joseph, AIDS 1st December 2019”

To uplift the spirits of the students, a flash mob was arranged by the National Service Scheme (NSS) members of KOSHYS INSTITUTE OF MANAGEMENT STUDIES. Additionally, the students received a concise health talk on AIDS, its causes, and preventive measures.

Prakashan
DIRECTOR
KOSHYS INSTITUTE OF MANGEMENT STUDIES
31/1, Kadusonnappanahalli,
Kannur Po, Hennur-Bagalur Road,
Bangalor-562 149

DIRECTOR



KOSHYS

INSTITUTE OF MANAGEMENT STUDIES

NAAC Accredited & ISO 9001 2015 Certified

ATTENDANCE SHEET

SL.NO	NAME	SEMESTER	ATTENDANCE
1	ABU RAIZAAL	II	A
2	ARUN KRISHNA P S	II	A
3	ABHIJITH BA	II	P
4	DANDE MAHESH	III	P
5	GHARSHOM ROY PETER	III	P
6	GOURINANDA SATHEESAN	III	P
7	JACKS N G	III	P
8	JIMMY KANAVIL JOHNSON	II	P
9	AMALKRISHNA KS	II	P
10	ROHITH R	II	P
11	MOHAMMED ANSAD	II	P
12	Rohit R Chandran	II	P
13	Abdul Rashiq	II	P
14	Samith Raju	II	P
15	SHAIK MEER FAZIL	II	P
16	SHAMIL CHERATTIYADAN	II	P
17	SHIJAS SUDHEER	II	P
18	VAIKUNTA PRABHU J	II	P
19	VIGNESH VK	II	P
20	VISMAYA M	II	P
21	Mohammed Sinan	II	A

Prakashan
DIRECTOR
KOSHYS INSTITUTE OF MANAGEMENT STUDIES
31/1, Kadusonnappanahalli,
Kannur Po, Hennur-Bagalur Road,
Bangalore-562 149

22	Archana Pramod	II	A
23	Shehansha	II	P
24	Mohammed Fidhan	II	P
25	MOD.WASIM DILAWAR	II	P
26	ABHINAV PU	II	P
27	ABIMANYU S	II	P
28	ABIYA MARY BIJU	II	P
29	JINO P MATHEW	II	P
30	JOEL GEORGE ALEX	II	P
31	JOMON SHAJI	II	P
32	MAHAMMAD FAIZ	II	P
33	MANISHA KM	II	P
34	MIJAS S	II	P
35	BENCY B GEORGE	II	P
36	Berjin R	II	P
37	Ehab Mohd Ansari	II	P
38	EMMANUEL BIJU	II	P
39	FAVAS U MOHAMMED ASHRAF	II	P
40	FEBIN P SABU	II	P
41	FEBIN P SIBI	II	P
42	Ganesh B	II	P
43	JAYASURYA	II	P
44	JEFFIN SAJU	II	P
45	JERIN JOY	II	P
46	Jibin P Samuel	II	P

DIRECTOR
 KOSHY'S INSTITUTE OF MANAGEMENT STUDIES
 # 31/1, Kadusonnappanahalli,
 Kannur Po, Hennur-Bagalur Road,
 Bangalor-562 149

DIRECTOR

5.1.2

LIFE SKILLS

[YOGA, HEALTH & HYGIENE AND ICT]

[Supporting Documents]

FOR

ACADEMIC YEAR 2018-2019



KOSHYS

INSTITUTE OF MANAGEMENT STUDIES

NAAC Accredited & ISO 9001 2015 Certified

DEPARTMENT OF PHYSICAL EDUCATION

Date: 11/06/2018

Circular

As part of our commitment to promoting holistic well-being and fostering a healthy lifestyle, we are delighted to announce the celebration of International Yoga Day on June 21, 2018. This event aims to create awareness about the numerous benefits of yoga and provide an opportunity for our college community to embrace this ancient practice.

DIRECTOR

KOSHYS INSTITUTE OF MANAGEMENT STUDIES
31/1, Kadusonnappanahalli,
Kannur Po, Hennur-Bagalur Road,
Bangalore-562 149

DIRECTOR



KOSHYS

INSTITUTE OF MANAGEMENT STUDIES

NAAC Accredited & ISO 9001 2015 Certified

Report on International Yoga Day celebration

Organized By

KOSHYS GROUP OF INSTITUTIONS

[On 21-06-2018, Thursday 10:00AM to 11:30 AM]

International Yoga Day was celebrated as on 21st June 2018 in the Auditorium at 10 am by the Koshys group of institutions under the guidance of Mr. Veeraraju, KIMS.

As we all know that “Yoga is an valuable gift of India’s ancient tradition. It embodies unity of mind and body; thought and action; restraint and fulfilment; harmony between man and nature; a holistic approach to health and well-being. It is not about exercise but to discover the sense of oneness with yourself, the world and the nature. By changing our lifestyle and creating consciousness, it can help in well being. Let us work towards adopting an International Yoga Day.”

The International Yoga Day celebration at Koshys Group Of Institution was a resounding success, fostering a sense of unity and well-being among the college community. The event not only provided valuable knowledge about the ancient practice of yoga but also encouraged individuals to embrace a healthier lifestyle. The overwhelming

DIRECTOR
KOSHYS INSTITUTE OF MANAGEMENT STUDIES
31/1, Kadusonnappanahalli,
Kannur Po, Hennur-Bagalur Road,
Bangalore-562 149

participation and positive feedback reflect the growing interest in incorporating yoga into the daily routines of the college community.

As we reflect on this celebration, it is evident that the International Yoga Day event at Koshys Group Of Institution played a pivotal role in promoting physical, mental, and spiritual well-being, fostering a sense of community, and encouraging a commitment to a healthier and balanced life.

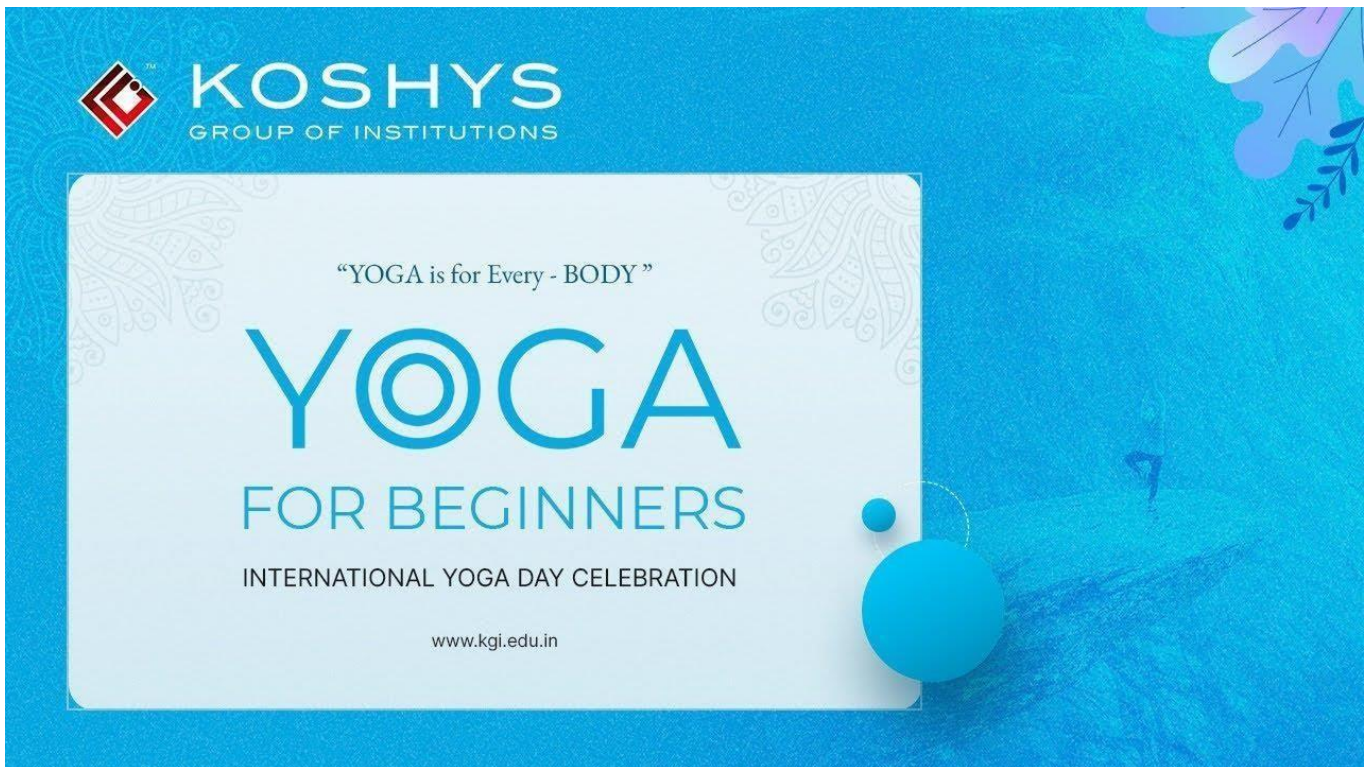

Prasanna
DIRECTOR
KOSHYS INSTITUTE OF MANAGEMENT STUDIES
31/1, Kadusonnappanahalli,
Kannur Po, Hennur-Bagalur Road,
Bangalore-562 149

DIRECTOR



KOSHYS

INSTITUTE OF MANAGEMENT STUDIES

NAAC Accredited & ISO 9001 2015 Certified

ATTENDANCE SHEET

SL.NO	STUDENT NAMES	SIGNATURE
1	Raman S	R
2	Shwathi weera	Shwathi
3	Ananya vijay	Ananya
4	Ankey Anoo	Ankey
5	Anand Kumar	Anand
6	Vishal R	Vishal
7	Joby	Joby
8	Aleena CR	Aleena
9	Mathew Jose	Mathew
10	Sibi George	Sibi
11	Maria EM	Maria
12	Aneena	Aneena
13	Sonu Sanu	Sonu
14	Jephay	Jephay
15	mini Jose	mini
16	Jomi	Jomi
17	Jose	Josef
18	Ashisi	Ashisi
19	Abi	Abi
20	Joman	Joman
21	Bibin	Bibin
22	mina	mina
23	pyrian	pyrian
24	Beno Biju	Beno
25	Jojel	Jojel
26	Arran	Arran
27	Joel	Joel
28	Silive	Silive

Prasanna
DIRECTOR
KOSHYS INSTITUTE OF MANAGEMENT STUDIES
31/1, Kadusonnappanahalli,
Kannur Po, Hennur-Bagalur Road,
Bangalore-562 149



KOSHYS™

INSTITUTE OF MANAGEMENT STUDIES

AFFILIATED TO BENGALURU NORTH UNIVERSITY

CERTIFICATE OF PARTICIPATION

THIS ACKNOWLEDGES THAT

Shine P S

Has participated in the

**“International Yoga Day” held on 21/06/2018 by the department of
Physical Education**

Principal

DIRECTOR
KOSHYS INSTITUTE OF MANAGEMENT STUDIES
311, Ketuonnappanahalli
Kannur Po, He-nur-IT-galur, Bangalore - 560075

Director



CERTIFICATE OF PARTICIPATION

THIS ACKNOWLEDGES THAT

Joshin Jacob

Has participated in the

**“International Yoga Day” held on 21/06/2018 by the department of
Physical Education**

A handwritten signature in blue ink, appearing to read "Shepherd", is written over a horizontal line.

Principal

A handwritten signature in blue ink, appearing to read "Sel", is written over a horizontal line.

DIRECTOR
KOSHYS INSTITUTE OF MANGEMENT STUDIES
31/1, Kadusonnappannahalli
Kannur Po, Hebbur, Bengaluru-560049
Bangalore-560049

Director



CERTIFICATE OF PARTICIPATION

THIS ACKNOWLEDGES THAT

K M Muskin

Has participated in the

“International Yoga Day” held on 21/06/2018 by the department of

A handwritten signature in blue ink, appearing to read "S. Sreekanth", is written over a horizontal line.

Principal

A handwritten signature in blue ink, appearing to read "S. Sreekanth", is written over a horizontal line.

DIRECTOR
KOSHYS INSTITUTE OF MANGEMENT STUDIES
31/1, Kadusonnappannahalli
Kannur Po, Hebbur, Bengaluru-560049
Bangalore-560049

Director



Physical Education

CERTIFICATE OF PARTICIPATION

THIS ACKNOWLEDGES THAT

Ashitha K

Has participated in the
“International Yoga Day” held on 21/06/2018 by the department of
Physical Education

Principal

DIRECTOR
KOSHY'S INSTITUTE OF MANAGEMENT STUDIES
31/1, Kadusonnappannahalli
Kannur Po, Hebbur, Bengaluru-560075
Bangalore - 560075

Director



CERTIFICATE OF PARTICIPATION

THIS ACKNOWLEDGES THAT

Anju U

Has participated in the

**“International Yoga Day” held on 21/06/2018 by the department of
Physical Education**

Deepthi

DIRECTOR
KOSHYS INSTITUTE OF MANAGEMENT STUDIES
31/1, Kadusonnappanahalli
Kannur Po, Hebbur, Bengaluru
Bangalore - 560049

Director



KOSHYS

INSTITUTE OF MANAGEMENT STUDIES

NAAC Accredited & ISO 9001 2015 Certified

DEPARTMENT OF BCA

Date: 14/09/2018

Circular

This is to inform that Department of BCA is conducting two-days boot camp workshop for “Android Development” for second year BCA students on 20th September, 2018 in the seminar hall. Participation is compulsory for everyone.

DIRECTOR
KOSHYS INSTITUTE OF MANAGEMENT STUDIES
31/1, Kadusonnappanahalli,
Kannur Po, Hennur-Bagalur Road,
Bangalore-562 149

DIRECTOR



KOSHYS

INSTITUTE OF MANAGEMENT STUDIES

NAAC Accredited & ISO 9001 2015 Certified

REPORT

The Two-Day Android Development Boot Camp Workshop provided participants with a condensed and immersive learning experience in Android app development conducted by Manohar Singh. The combination of theoretical knowledge, hands-on labs, and exposure to industry best practices contributed to a well-rounded and impactful workshop.

Feedback from participants was positive overall. Attendees appreciated the practical nature of the workshop, the depth of coverage, and the opportunity to build a real Android app. Many participants expressed confidence in their ability to start their journey as Android developers.

The workshop heavily emphasized hands-on learning through labs, coding challenges, and practical exercises. Participants engaged in real-world scenarios, building Android apps and solving development challenges.

Praveen
DIRECTOR
KOSHYS INSTITUTE OF MANAGEMENT STUDIES
31/1, Kadusonnappanahalli,
Kannur Po, Hennur-Bagalur Road,
Bangalore-562 149

DIRECTOR

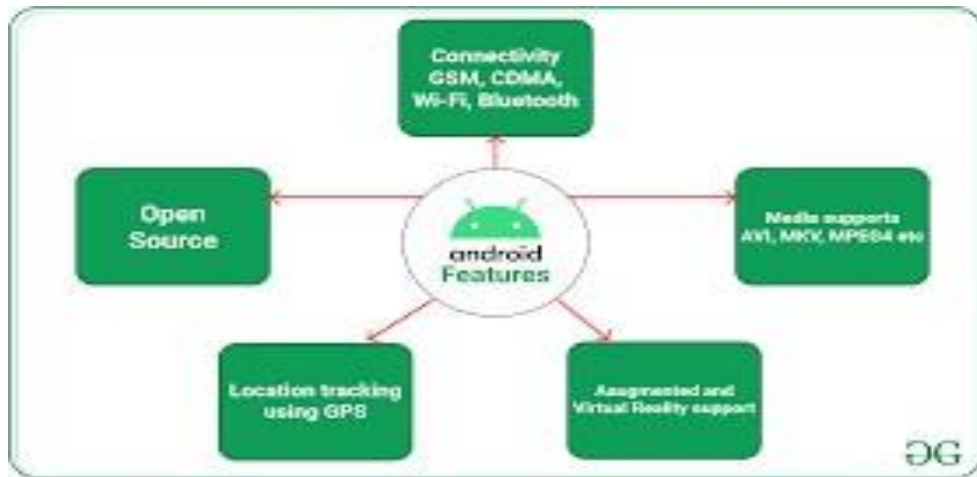

Prakash
DIRECTOR
KOSHY'S INSTITUTE OF MANAGEMENT STUDIES
31/1, Kadusonnappanahalli,
Kannur Po, Hennur-Bagalur Road,
Bangalore-562 149

DIRECTOR

CERTIFICATE

— OF PARTICIPATION —

This is to Certify That

CHANDHU

This is a certify that Chandhu has participated in the Two day Boot Camp Workshop on Android Development held at koshy's Institute of management studies from 20th to 21th September 2018

Prof. Sandhya S
Principal

Dr. Prakash B Nayak
Director

DIRECTOR
KOSHYS INSTITUTE OF MANAGEMENT STUDIES
31/1, Kadusonnappanahalli,
Kannur Po, Hennur-Bagalur Road,
Bangalore-562 149

CERTIFICATE

OF PARTICIPATION

This is to Certify That

SUPRIYA M

This is a certify that Supriya has participated in the Two day Boot Camp Workshop on Android Development held at koshy's Institute of management studies from 20th to 21th September 2018

Prof. Sandhya S
Principal

Dr. Prakash B Nayak
Director

DIRECTOR
KOSHYS INSTITUTE OF MANGEMENT STUDIES
31/1, Kadusonnappanahalli,
Kannur Po, Hennur-Bagalur Road,
Bangalore-562 149



Android

Application Development A

Tutorial Driven Course

Prakashan

DIRECTOR
KOSHYS INSTITUTE OF MANGEMENT STUDIES
31/1, Kadusonnappanahalli,
Kannur Po, Hennur-Bagalur Road,
Bangalor-562 149



Java

- Basic Java programming
 - Exceptions
 - Inner Class, Interface
- Advanced topics we will touch:
 - Java IO
 - Java Thread
 - Java Socket

Prakashon

DIRECTOR
KOSHYS INSTITUTE OF MANGEMENT STUDIES
31/1, Kadusonnappanahalli,
Kannur Po, Hennur-Bagalur Road,
Bangalor-562 149



Android Basics

Credit goes to Google!

Prakashon

DIRECTOR
KOSHYS INSTITUTE OF MANGEMENT STUDIES
31/1, Kadusonnappanahalli,
Kannur Po, Hennur-Bagalur Road,
Bangalor-562 149



Course Objectives

- Mobile Application Development (MAD)
- Intro to Android platform
- Platform architecture
- Application building blocks
- Development tools
- Textbook: Hello, Android

Prakashan

DIRECTOR
KOSHYS INSTITUTE OF MANGEMENT STUDIES
31/1, Kadusonnappanahalli,
Kannur Po, Hennur-Bagalur Road,
Bangalor-562 149



Few reasons to go MAD...

- Smart Phones
 - Internet access anywhere –
 - Social networking
- Millions of mobile users
- Open standards

Prakashan

DIRECTOR
KOSHYS INSTITUTE OF MANGEMENT STUDIES
31/1, Kadusonnappanahalli,
Kannur Po, Hennur-Bagalur Road,
Bangalor-562 149

Introduction to Android



- Open software platform for mobile development
- A complete stack – OS, Middleware, Applications
- An Open Handset Alliance (OHA) project
- Powered by Linux operating system
- Fast application development in Java
- Open source under the Apache 2 license

Prakash
DIRECTOR
KOSHYS INSTITUTE OF MANGEMENT STUDIES
31/1, Kadusonnappanahalli,
Kannur Po, Hennur-Bagalur Road,
Bangalor-562 149

APPLICATIONS

Home

Contacts

Phone

Browser

...

APPLICATION FRAMEWORK

Activity Manager

Window Manager

Content Providers

View System

Package Manager

Telephony Manager

Resource Manager

Location Manager

Notification Manager

LIBRARIES

Surface Manager

Media Framework

SQLite

OpenGL | ES

FreeType

WebKit

SGL

SSL

libc

ANDROID RUNTIME

Core Libraries

Dalvik Virtual Machine

LINUX KERNEL

Display Driver

Camera Driver

Flash Memory Driver

Binder (IPC) Driver

Keypad Driver

WiFi Driver

Audio Drivers

Power Management

Karanth
DIRECTOR
KOSHYS INSTITUTE OF MANAGEMENT STUDIES
31/1, Kadusonnappanahalli,
Kannur Po, Hennur-Bagalur Road,
Bangalore-562 149



Linux Kernel

- Works as a HAL
- Device drivers
- Memory management
- Process management
- Networking



Prasanna
DIRECTOR
KOSHYS INSTITUTE OF MANGEMENT STUDIES
31/1, Kadusonnappanahalli,
Kannur Po, Hennur-Bagalur Road,
Bangalor-562 149



Libraries

- C/C++ libraries
- Interface through Java
- Surface manager – Handling UI Windows
- 2D and 3D graphics
- Media codecs, SQLite, Browser engine



Prakashon
DIRECTOR
KOSHYS INSTITUTE OF MANGEMENT STUDIES
31/1, Kadusonnappanahalli,
Kannur Po, Hennur-Bagalur Road,
Bangalor-562 149



Android Runtime

- Dalvik VM
 - Dex files
 - Compact and efficient than class files
 - Limited memory and battery power
- Core Libraries
 - Java 5 Std edition
 - Collections, I/O etc...



Prakash
DIRECTOR
KOSHYS INSTITUTE OF MANGEMENT STUDIES
31/1, Kadusonnappanahalli,
Kannur Po, Hennur-Bagalur Road,
Bangalor-562 149

Application Framework



- API interface
- Activity manager – manages application life cycle

Prakashan
DIRECTOR
KOSHYS INSTITUTE OF MANGEMENT STUDIES
31/1, Kadusonnappanahalli,
Kannur Po, Hennur-Bagalur Road,
Bangalor-562 149

Applications



- Built in and user apps
- Can replace built in apps

Prakashan

DIRECTOR
KOSHYS INSTITUTE OF MANGEMENT STUDIES
31/1, Kadusonnappanahalli,
Kannur Po, Hennur-Bagalur Road,
Bangalor-562 149



Course Objectives

- Mobile Application Development (MAD)
- Intro to Android platform
- Platform architecture
- **Application building blocks**
- Development tools
- Textbook: Hello, Android

Prakashan

DIRECTOR
KOSHYS INSTITUTE OF MANGEMENT STUDIES
31/1, Kadusonnappanahalli,
Kannur Po, Hennur-Bagalur Road,
Bangalor-562 149

Application Building Blocks



- Activity
- IntentReceiver
- Service
- ContentProvider

Prakashan
DIRECTOR
KOSHYS INSTITUTE OF MANGEMENT STUDIES
31/1, Kadusonnappanahalli,
Kannur Po, Hennur-Bagalur Road,
Bangalor-562 149



Activities

- Typically correspond to one UI screen
- But, they can:
 - Be faceless
 - Be in a floating window
 - Return a value

Prakashan

DIRECTOR
KOSHYS INSTITUTE OF MANGEMENT STUDIES
31/1, Kadusonnappanahalli,
Kannur Po, Hennur-Bagalur Road,
Bangalor-562 149



IntentReceivers

- Components that respond to broadcast 'Intents'
- Way to respond to external notification or alarms
- Apps can invent and broadcast their own Intent

Prakashan

DIRECTOR
KOSHYS INSTITUTE OF MANGEMENT STUDIES
31/1, Kadusonnappanahalli,
Kannur Po, Hennur-Bagalur Road,
Bangalor-562 149



Intents

- Think of Intents as a verb and object; a description of what you want done
 - E.g. VIEW, CALL, PLAY etc..
- System matches Intent with Activity that can best provide the service
- Activities and IntentReceivers describe what Intents they can service

Prakashan

DIRECTOR
KOSHYS INSTITUTE OF MANGEMENT STUDIES
31/1, Kadusonnappanahalli,
Kannur Po, Hennur-Bagalur Road,
Bangalor-562 149



Lifecycle

- System Process



- Home

- Mail

- Map

- Browser

Prakashan

DIRECTOR
KOSHYS INSTITUTE OF MANGEMENT STUDIES
31/1, Kadusonnappanahalli,
Kannur Po, Hennur-Bagalur Road,
Bangalor-562 149

Location Manager

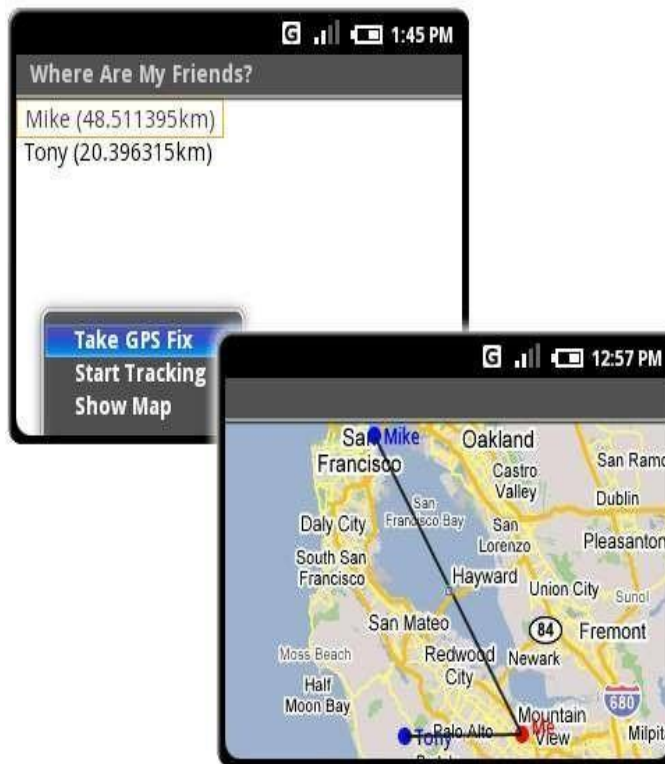

Praxanthon
DIRECTOR
KOSHYS INSTITUTE OF MANGEMENT STUDIES
31/1, Kadusonnappanahalli,
Kannur Po, Hennur-Bagalur Road,
Bangalor-562 149



XMPP Services

- Allows any app to send device-to-device messages to other android users
- Data Messages are Intents with name/value pairs
- Works with any gmail account...
- Can also build servers to deliver server-to-device messages

Prakash

DIRECTOR
KOSHYS INSTITUTE OF MANGEMENT STUDIES
31/1, Kadusonnappanahalli,
Kannur Po, Hennur-Bagalur Road,
Bangalor-562 149

Notification Manager



Prakashan

DIRECTOR
KOSHYS INSTITUTE OF MANGEMENT STUDIES
31/1, Kadusonnappannahalli,
Kannur Po, Hennur-Bagalur Road,
Bangalore-562 149



Notification Manager

- How background app interact with users
- Consistent notification presentation

Prakashan

DIRECTOR
KOSHYS INSTITUTE OF MANGEMENT STUDIES
31/1, Kadusonnappanahalli,
Kannur Po, Hennur-Bagalur Road,
Bangalor-562 149

Views



Pranab
DIRECTOR
KOSHYS INSTITUTE OF MANGEMENT STUDIES
31/1, Kadusonnappanahalli,
Kannur Po, Hennur-Bagalur Road,
Bangalor-562 149

Views



Praxanthon

DIRECTOR
KOSHYS INSTITUTE OF MANGEMENT STUDIES
31/1, Kadusonnappanahalli,
Kannur Po, Hennur-Bagalur Road,
Bangalor-562 149

Location Manager



Prakashan

DIRECTOR
KOSHYS INSTITUTE OF MANGEMENT STUDIES
31/1, Kadusonnappanahalli,
Kannur Po, Hennur-Bagalur Road,
Bangalor-562 149



End of Lecture

- First task, install the SDK and Eclipse for instructions detailed in Assignment #1
- Will be performed in class as well.

Praxanthon
DIRECTOR
KOSHYS INSTITUTE OF MANGEMENT STUDIES
31/1, Kadusonnappanahalli,
Kannur Po, Hennur-Bagalur Road,
Bangalor-562 149



KOSHYS

KOSHYS INSTITUTE OF MANAGEMENT STUDIES

ISO 9001:2015 Certified & ISO 9001:2015 Certified

ATTENDANCE SHEET

SL.NO	STUDENT NAMES	SIGNATURE
1.	Akhsa	Akhsa
2.	Gagana.V	Gagana.V
3.	Chandana.V	Chandana.V
4.	Asha.G	Asha.G
5.	Deppa.S	Deppa.S
6.	Alphin Antony	Alphin Antony
7.	Anajith mp	Anajith mp
8.	Aswin MB	Aswin MB
9.	Jibin.G. Ji.Ji	Jibin
10.	Jehine Corveya	Jehine
11.	Guchal krishna K.S	Guchal
12.	Devdat.v. prasad	Devdat
13.	Anantha Krishna V Nair	Anantha
14.	Jishnu.G.Nair	Jishnu
15.	Anajith.M.S	Anajith
16.	Ajayan	Ajayan
17.	Arega.P	Arega
18.	Nandana Umni	Nandana
19.	chandrika	chandrika
20.	Jayachandra.	Jayachandra
21.	Subhramani	Subhramani
22.	Leo das	Leo Das
23.	Nikhil	Nikhil
24.	Ajay.T	Ajay
25.	Vishwa	Vishwa
26.	Asif.M	Asif
27.	Anikha S	Anikha S
28.	Saran Shakthi	Saran

Pranavon
DIRECTOR
KOSHYS INSTITUTE OF MANAGEMENT STUDIES
31/1, Kadusonnappanahalli,
Kannur Po, Hennur-Bagalur Road,
Bangalore-562 149



KOSHYS

INSTITUTE OF MANAGEMENT STUDIES

NAAC Accredited & ISO 9001 2015 Certified

DEPARTMENT OF BCom

Date: 05/03/2018

Circular

Department of B.com is conducting a seminar on Nutrition Awareness Program on 09/03/2018 at 11am in auditorium for all the students of UG. All students and faculty within the department are kindly asked to participate in this event.

DIRECTOR
KOSHYS INSTITUTE OF MANAGEMENT STUDIES
31/1, Kadusonnappanahalli,
Kannur Po, Hennur-Bagalur Road,
Bangalore-562 149

DIRECTOR



KOSHYS

INSTITUTE OF MANAGEMENT STUDIES

NAAC Accredited & ISO 9001 2015 Certified

REPORT



“Speaker Ms. Linta Thomas : date: 09/03/2018”

Praxanthan
DIRECTOR
KOSHYS INSTITUTE OF MANAGEMENT STUDIES
31/1, Kadusonnappanahalli,
Kannur Po, Hennur-Bagalur Road,
Bangalore-562 149

The Nutrition Awareness Program, held on March 9th, 2018, conducted by Ms. Linta Thomas, Vice Principal KIHS, aimed to educate participants about the significance of maintaining a balanced diet and adopting healthy eating habits.

The primary objective of the program was to raise awareness about the importance of nutrition in maintaining overall health and well-being. The program commenced at 11 am in the auditorium, with an enthusiastic turnout of 120 students. It consisted of various informative sessions, interactive workshops, and engaging activities focused on nutrition-related topics.

The Nutrition Awareness Program concluded successfully, achieving its goal of educating attendees about the vital role of nutrition in leading a healthy life. The engagement and active participation of the audience reflected their interest and enthusiasm in adopting healthier dietary practices.

We extend our gratitude to all the speakers, volunteers, and participants for their valuable contributions, making the event a resounding success.

DIRECTOR
KOSHY'S INSTITUTE OF MANAGEMENT STUDIES
31/1, Kadusonnappanahalli,
Kannur Po, Hennur-Bagalur Road,
Bangalore-562 149

DIRECTOR



KOSHYS

INSTITUTE OF MANAGEMENT STUDIES

NAAC Accredited & ISO 9001 2015 Certified

ATTENDANCE SHEET

SL.NO	STUDENT NAMES	SIGNATURE
1	MUKESH	
2	Karthik, R	
3	Varun, K	
4	Jhon S	
5	Pruthvi	
6	Kashinath, N	
7	Manu gouda.	
8	Chandan, R	
9	Harsha	
10	Mari	
11	Santosh	
12	Sanjo	
13	Sujatha	
14	Munesh	
15	Puneeth	
16	Rejinee	
17	Antony Resi	
18	waseem	
19	Rajesh	
20	Santosh	
21	Naga	
22	Nagaraj	
24	Manjo	
25	Marianna	
26	Keishora	
27	Arisueth	
28	Akshy	
29	Varshith	

DIRECTOR
KOSHYS INSTITUTE OF MANAGEMENT STUDIES
31/1, Kadusonnappanahalli,
Kannur Po, Hennur-Bagalur Road,
Bangalore-562 149

30	Priganti, T	Priganti
31	Vaishali, T	Vaishali
32	Ram	Ram
33	Bindu	Bindu
34	Mia latha	Mia
35	hazri krishna	H. Hazri
36	mohan.	Mohan
37	Vrunda, K	Vrunda
38	Manu	Manu
39	Siddhanta	Siddhanta
40	Shivkumar	Shiv
41	Ninu	Ninu
42	Dharsan	Dharsan
43	Yaduchandera	Yad
44	manohara	manu
45	Robert	Robert
46	Vasanth	Vasanth
47	nagendera	Nagendera
48	Yadu	Yadu
49	sushobha	Sushobha

DIRECTOR
 KOSHS INSTITUTE OF MANGEMENT STUDIES
 # 31/1, Kadusonnappanahalli,
 Kannur Po, Hennur-Bagalur Road,
 Bangalor-562 149



KOSHYS™

INSTITUTE OF MANAGEMENT STUDIES

AFFILIATED TO BENGALURU NORTH UNIVERSITY

CERTIFICATE OF APPRECIATION

THIS ACKNOWLEDGES THAT

Sanjay V

Has participated in the

**Health & Hygiene program focused on “Nutrition Awareness Program”
held on 09/03/2018 by the department of BCom**

Principal

DIRECTOR
KOSHYS INSTITUTE OF MANGEMENT STUDIES
31/1, Kadusonnappanahalli
Kannur Po, Hennur Bagalur Road
Bangalore - 560 049

Director



KOSHYS™

INSTITUTE OF MANAGEMENT STUDIES

AFFILIATED TO BENGALURU NORTH UNIVERSITY

CERTIFICATE OF APPRECIATION

THIS ACKNOWLEDGES THAT

Usha S

Has participated in the

**Health & Hygiene program focused on “Nutrition Awareness Program”
held on 09/03/2018 by the department of BCom**

Principal

DIRECTOR
KOSHYS INSTITUTE OF MANGEMENT STUDIES
31/1, Kadusonnappanahalli
Kannur Po, Hennur Bagalur Road
Bangalore - 560 049

Director



KOSHYS™

INSTITUTE OF MANAGEMENT STUDIES

AFFILIATED TO BENGALURU NORTH UNIVERSITY

CERTIFICATE OF APPRECIATION

THIS ACKNOWLEDGES THAT

Akash L

Has participated in the

**Health & Hygiene program focused on “Nutrition Awareness Program”
held on 09/03/2018 by the department of BCom**

Principal

DIRECTOR
KOSHYS INSTITUTE OF MANGEMENT STUDIES
31/1, Kadusonnappanahalli
Kannur Po, Hebbur, Bagalur Road
Bangalore, Karnataka 560049

Director

CERTIFICATE OF APPRECIATION

THIS ACKNOWLEDGES THAT

Vipin Kumar V

Has participated in the

**Health & Hygiene program focused on “Nutrition Awareness Program”
held on 09/03/2018 by the department of BCom**



Principal



DIRECTOR
KOSHY'S INSTITUTE OF MANAGEMENT STUDIES
31/1, Kadusonnappanahalli
Kannur Po, Healur Bagalur Road
Bangalore - 560 149

Director

CERTIFICATE OF APPRECIATION

THIS ACKNOWLEDGES THAT

Sindhu M

Has participated in the

**Health & Hygiene program focused on “Nutrition Awareness Program”
held on 09/03/2018 by the department of BCom**



Principal



DIRECTOR
KOSHY'S INSTITUTE OF MANAGEMENT STUDIES
31/1, Kadusonnappanahalli
Kannur Po, Healur Bagalur Road
Bangalore - 560 149

Director